

Tout savoir sur la génétique

Barbara Girerd



filiere-oscar.fr

FILIÈRE
SANTÉ
MALADIES
RARES

La génétique en images

La cellule et ses chromosomes

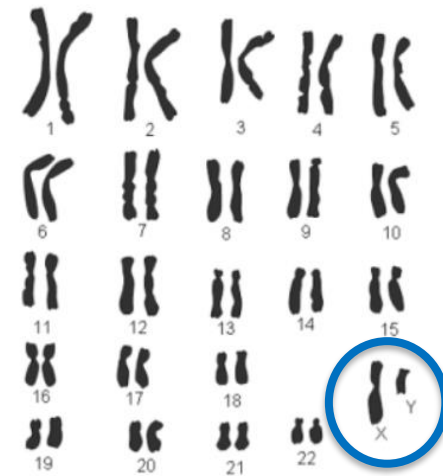
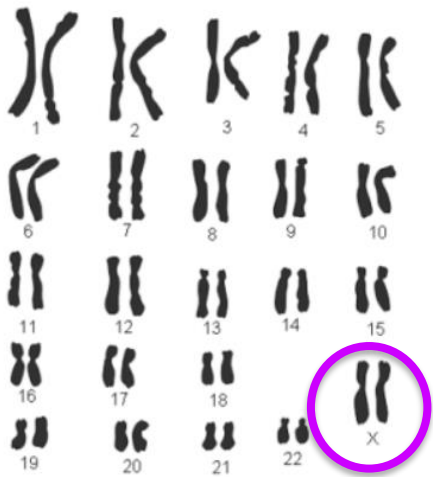
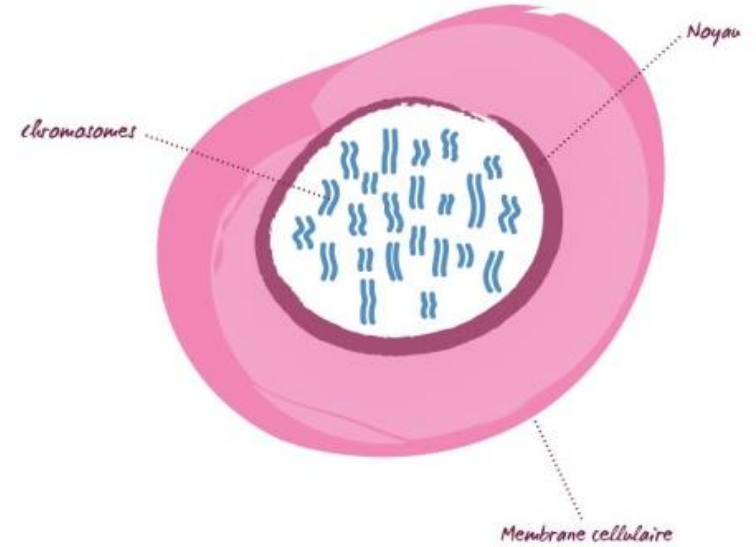
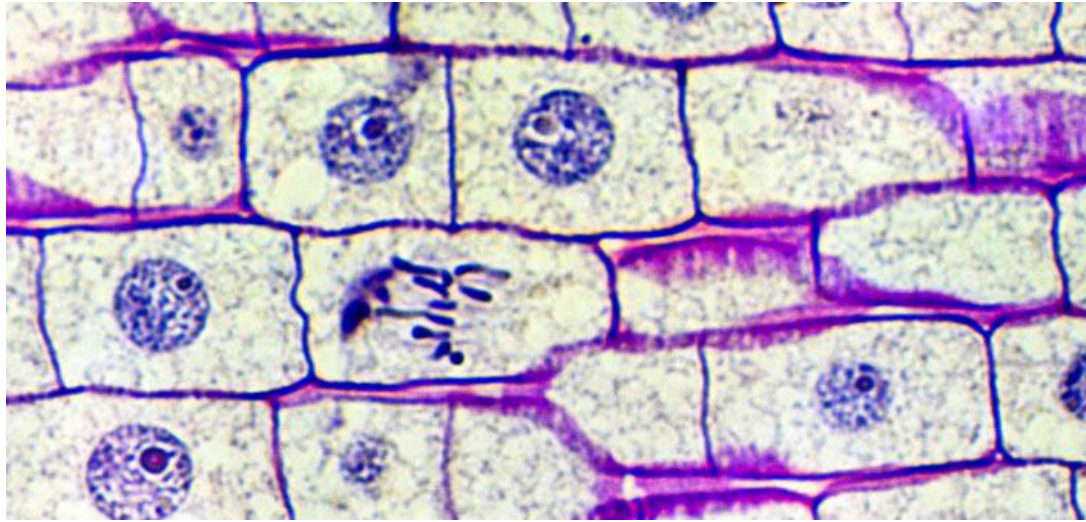

Les anomalies chromosomiques

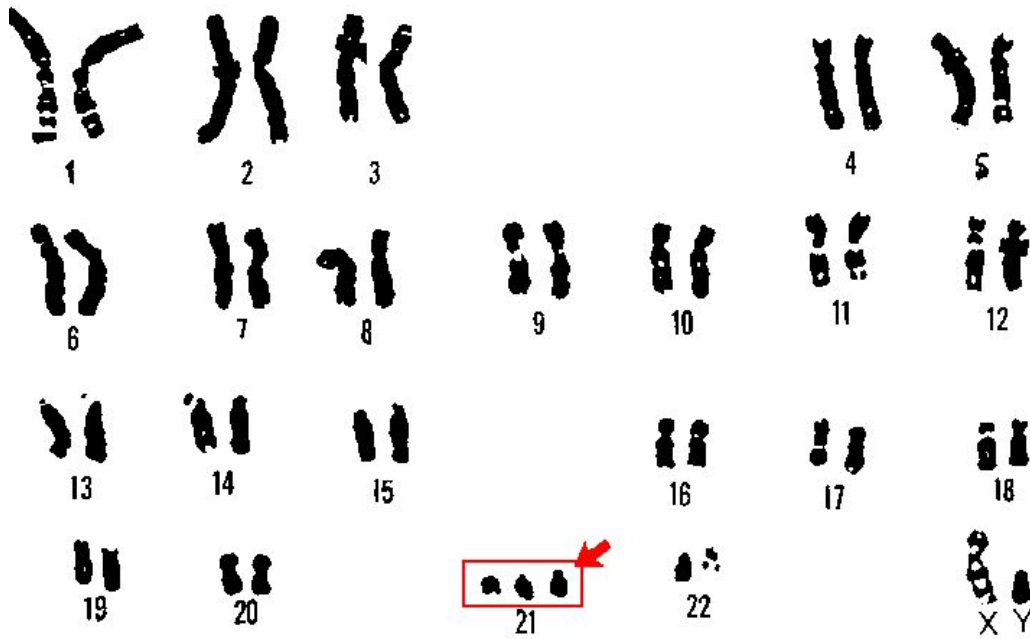

Les chromosomes

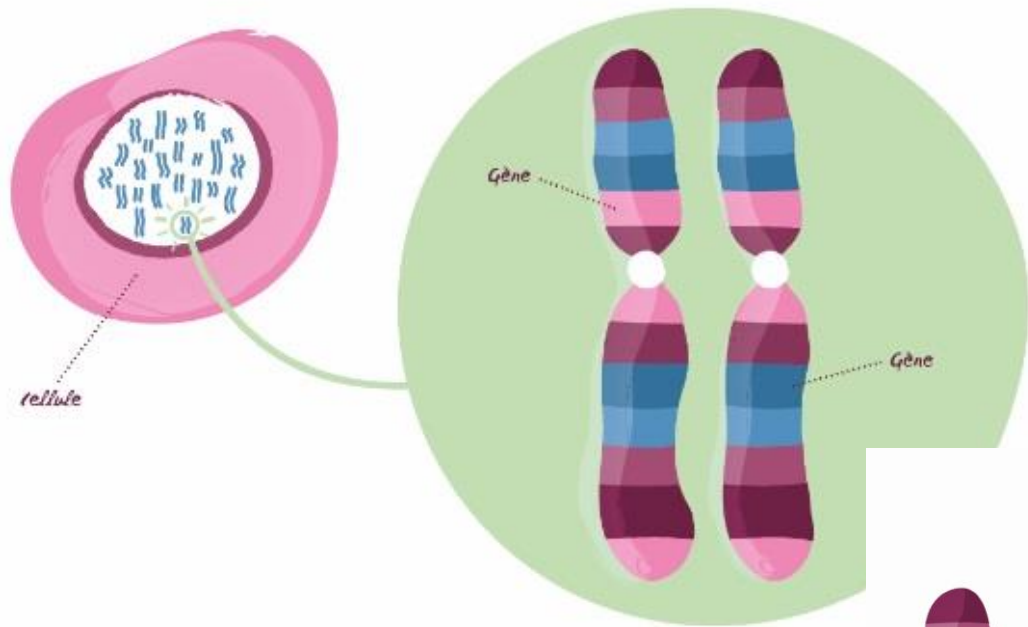

Les gènes

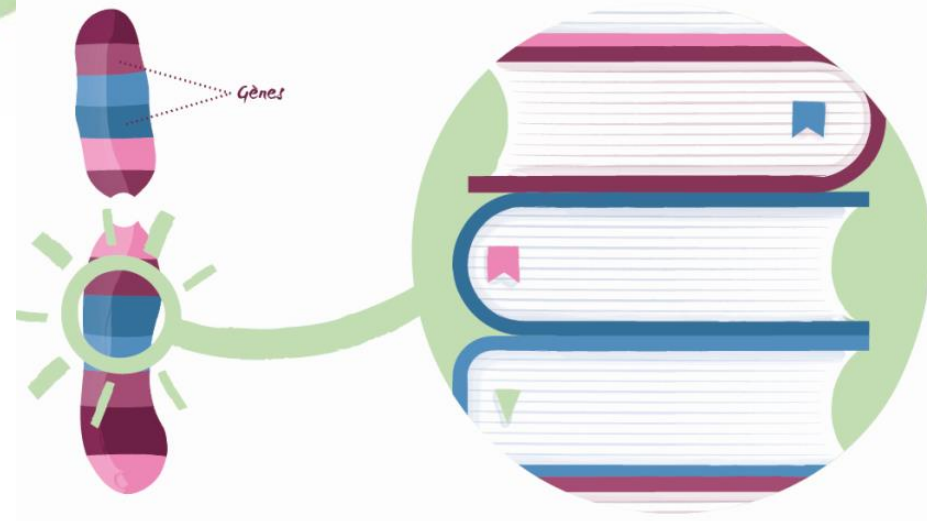

Les gènes

Gènes

20 000 gènes



Les anomalies génétiques ou mutations



*Anomalie génétique
ou mutation*

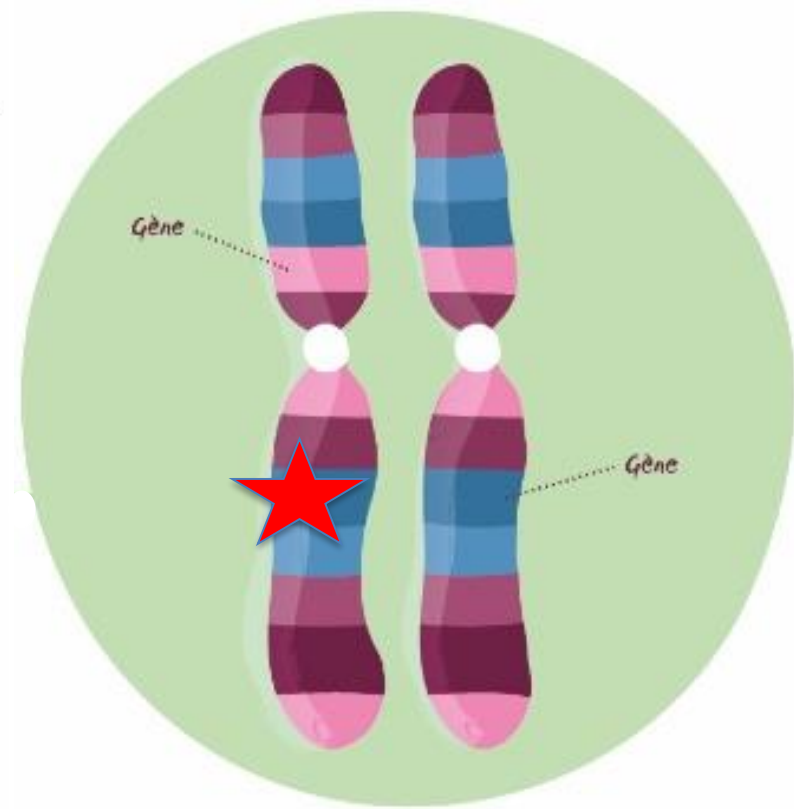



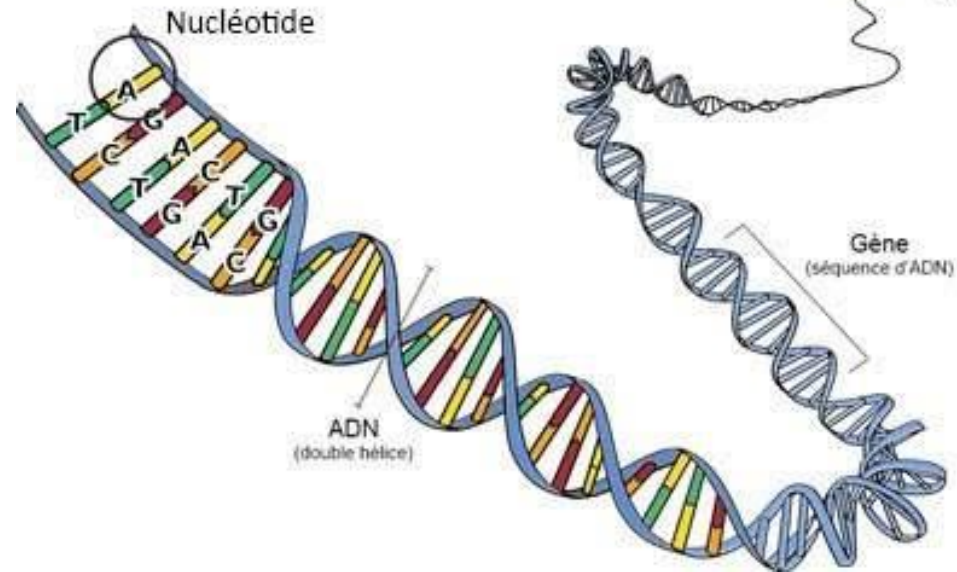
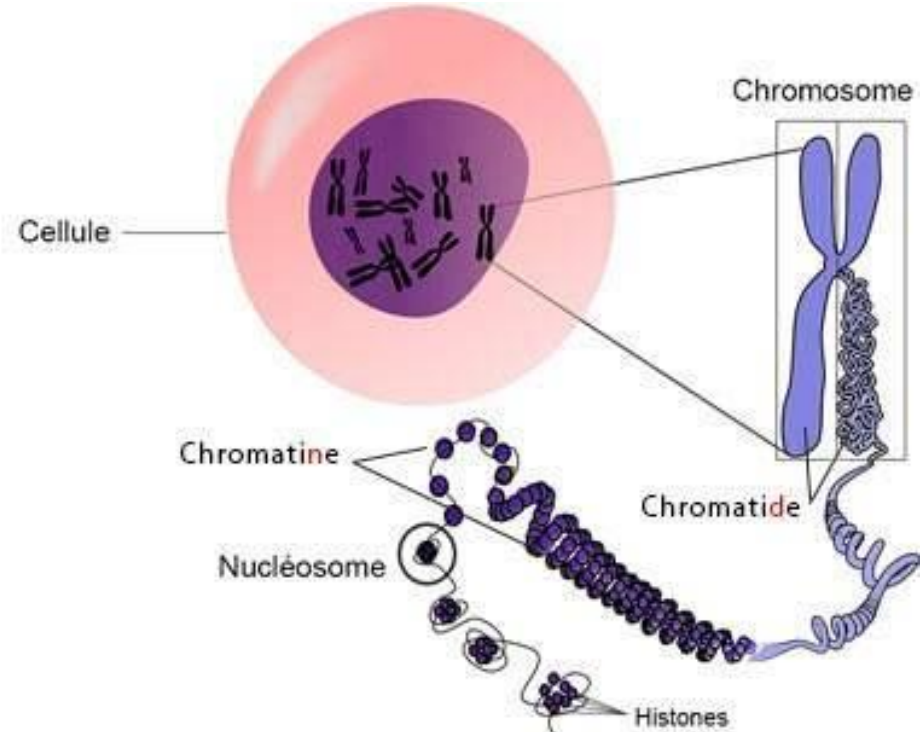
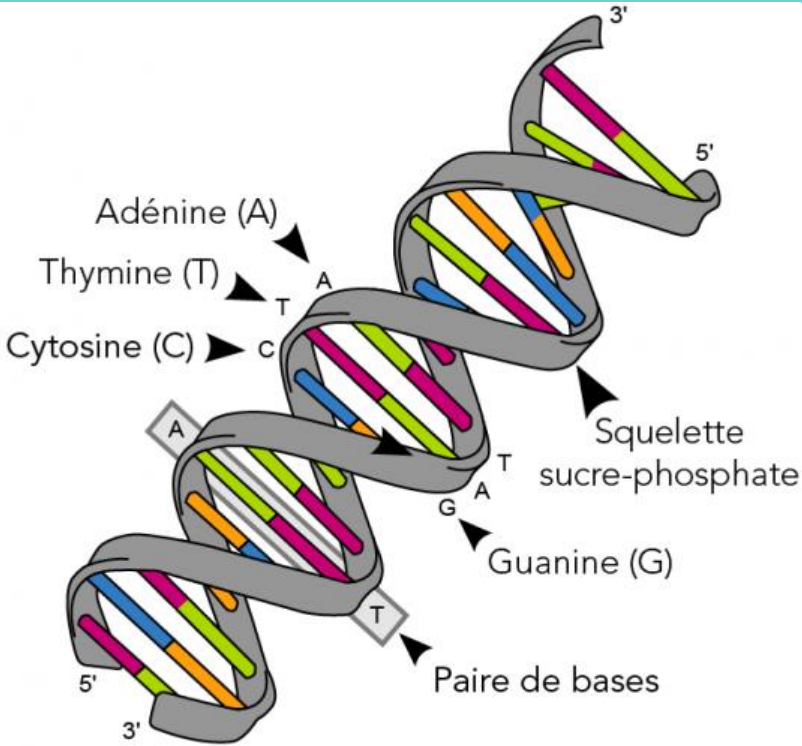

La multiplication des cellules

La division cellulaire et la mitose

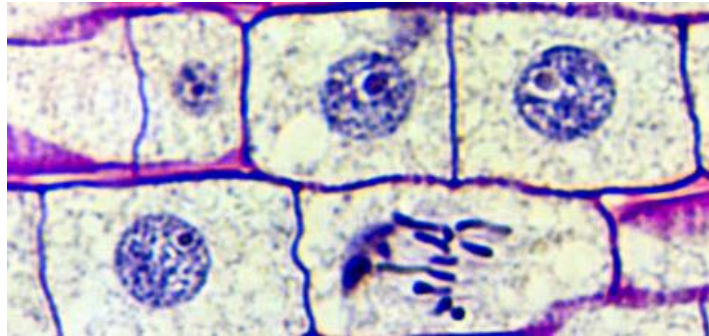
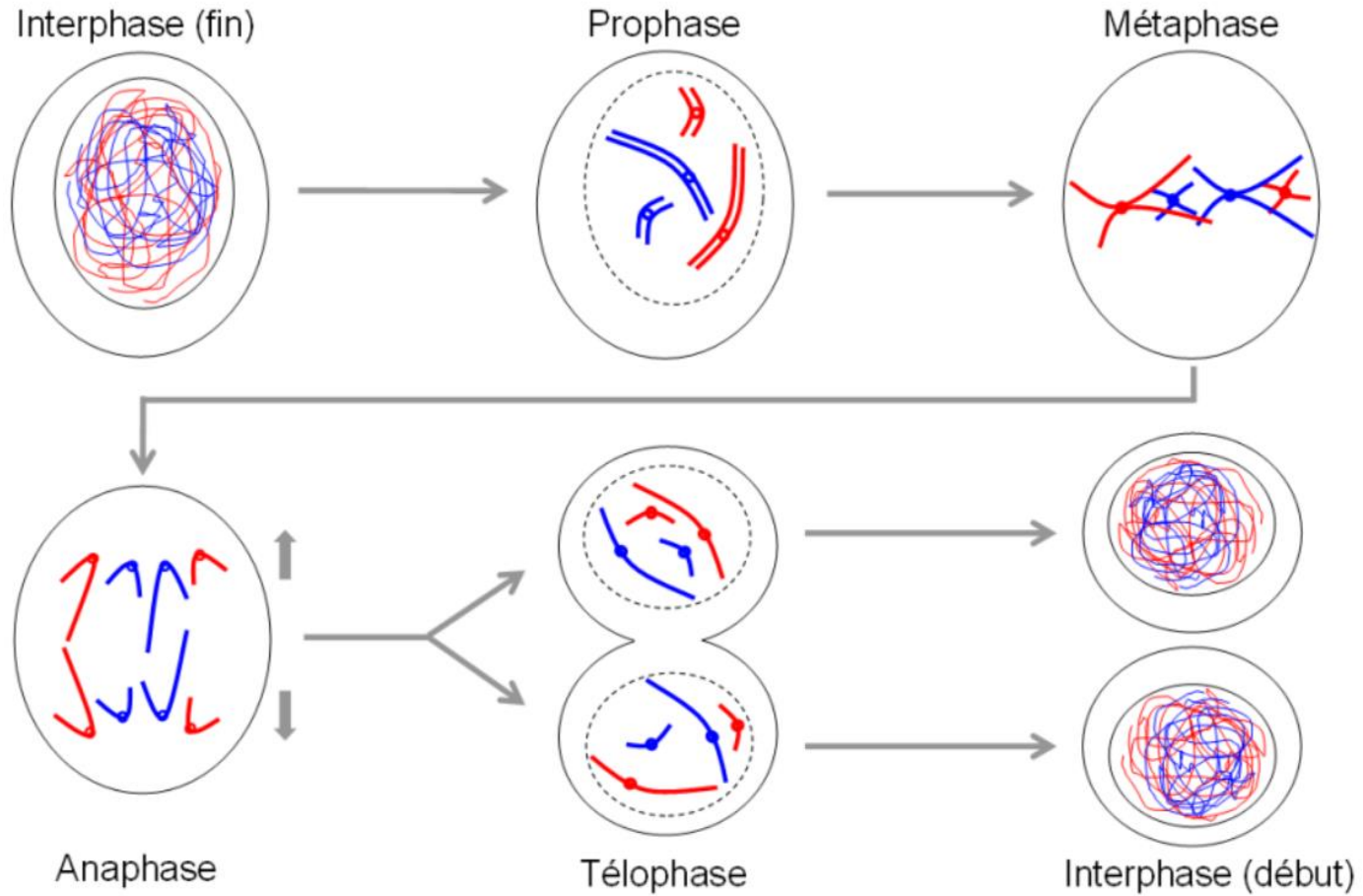

Et comment on fait les bébés?

Le brassage génétique

Au hasard, je vais prendre celui-ci, ...



FEMME

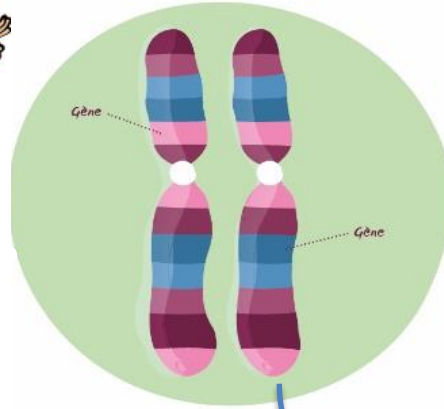

HOMME

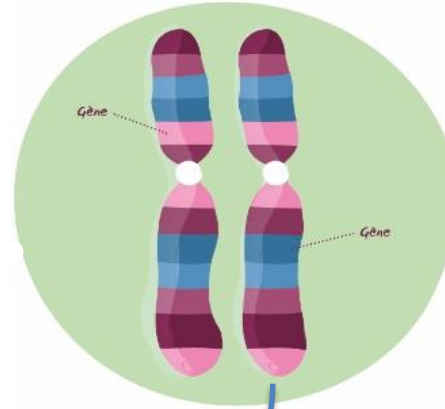

... et celui là !



Et voilà !

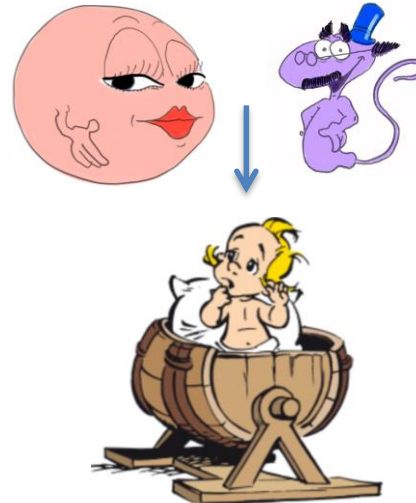

?



Le brassage génétique

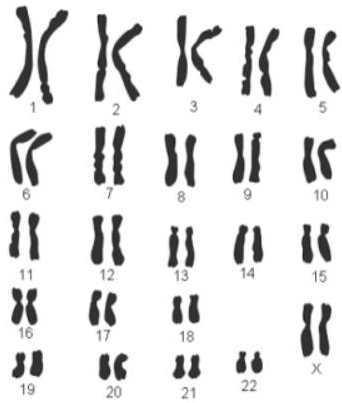

FEMME

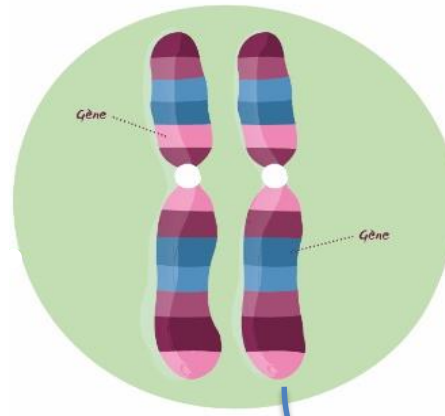

HOMME

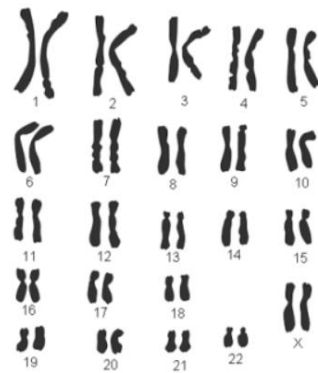
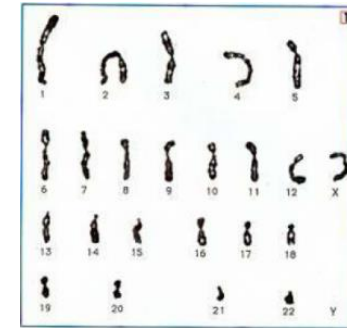
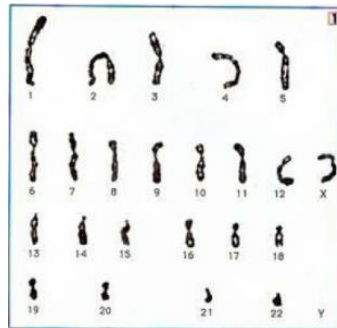
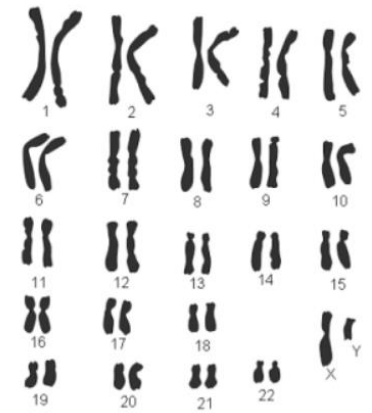
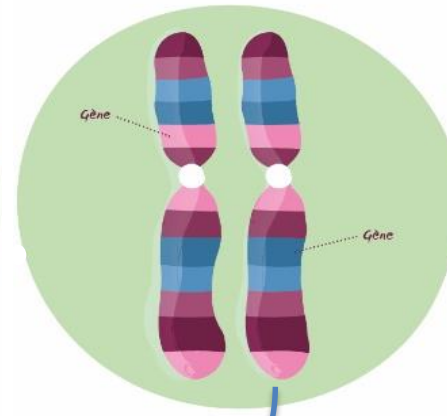

Fille ou gars ?

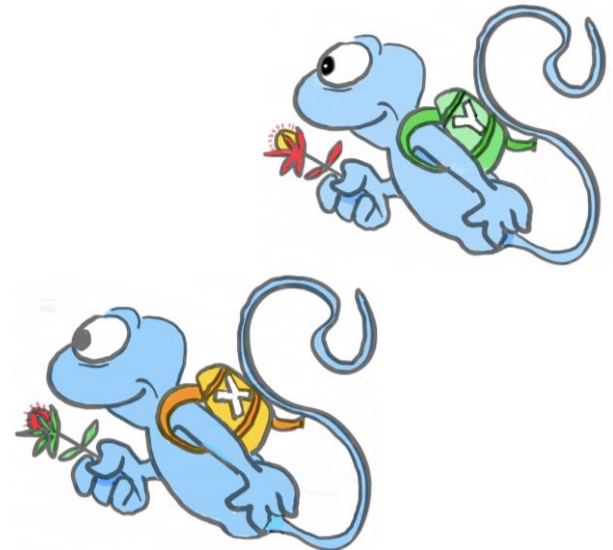
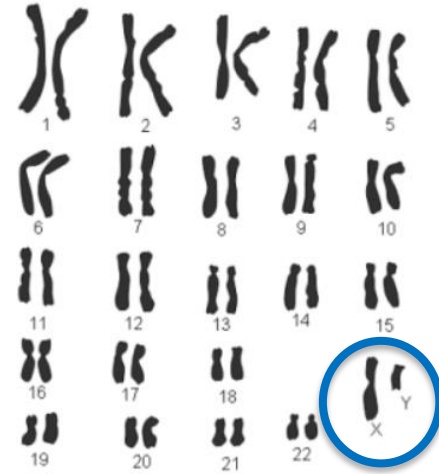
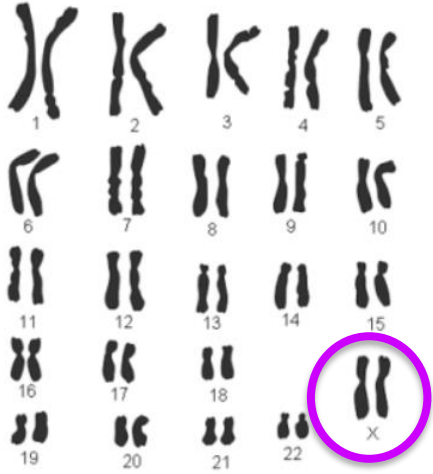

Et après les gènes?

Des gènes aux protéines

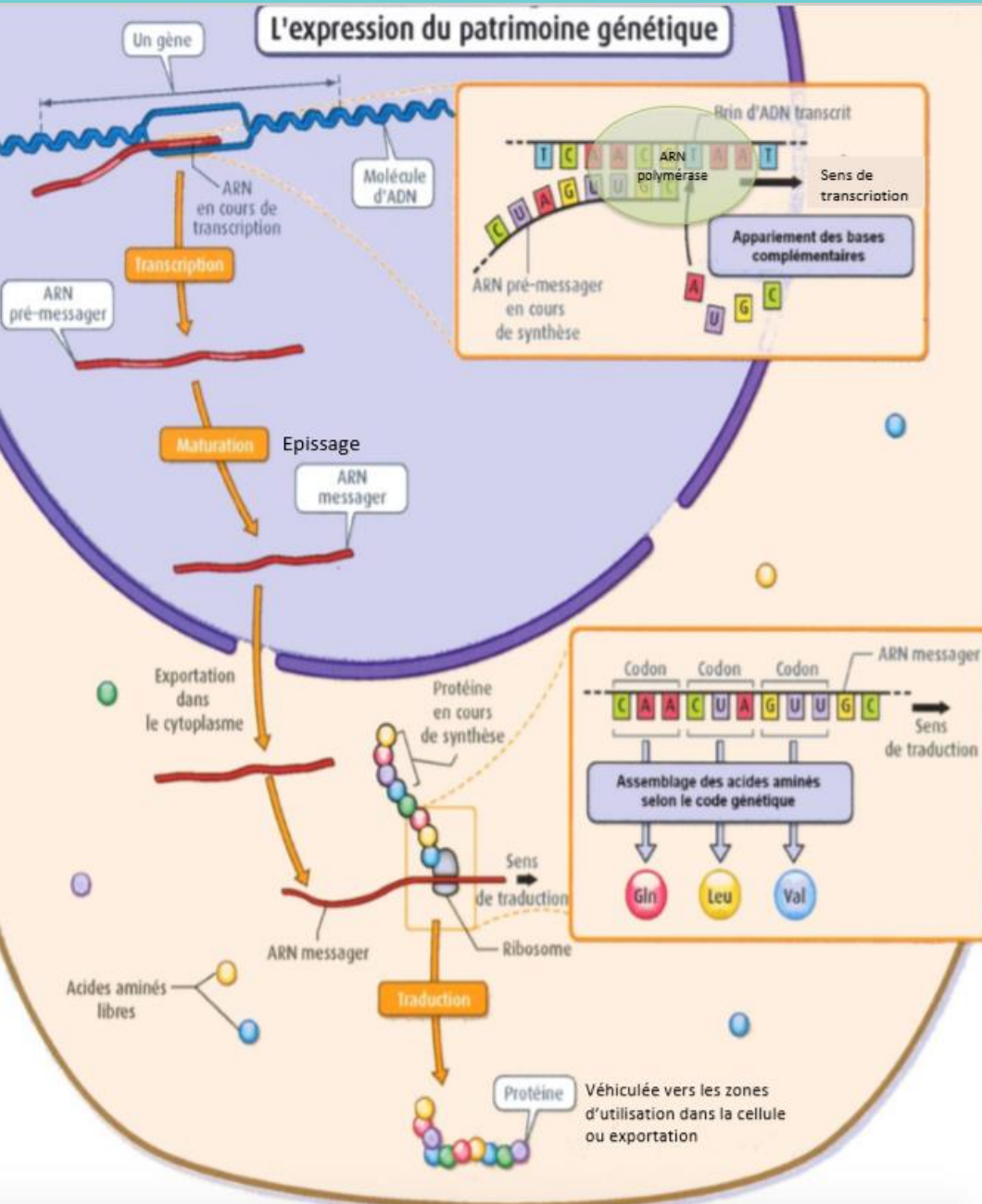

Des gènes aux protéines

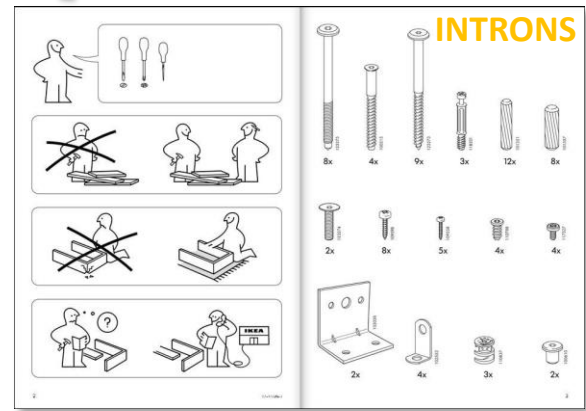
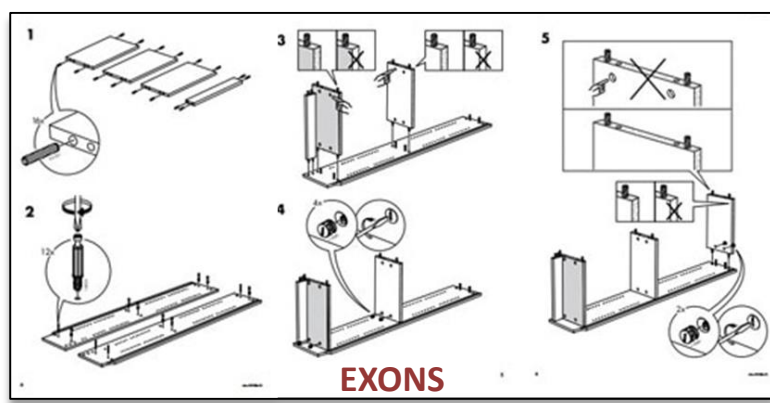
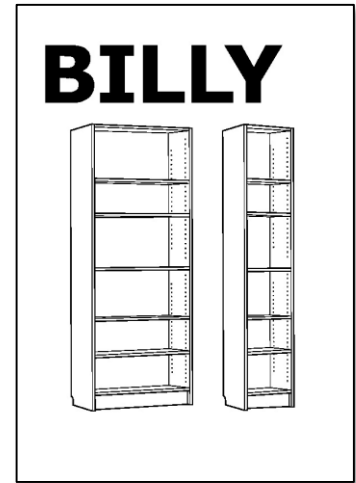
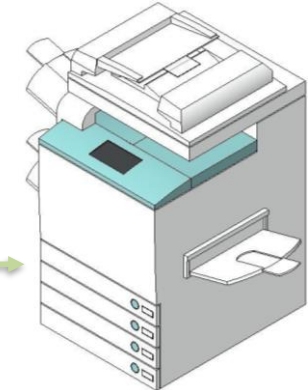
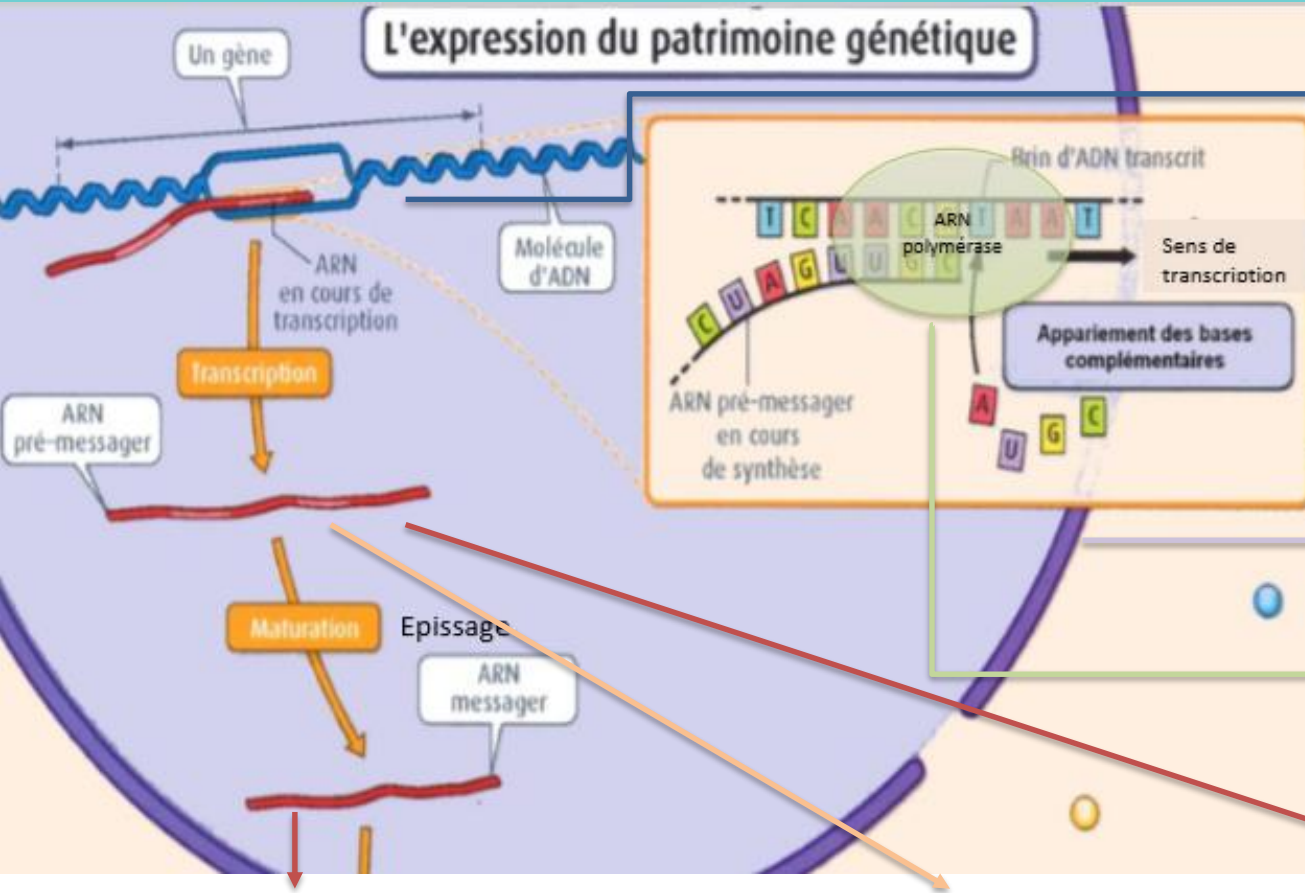

De l'ADN à l'ARNm

ADN d'un chromosome
interphasique

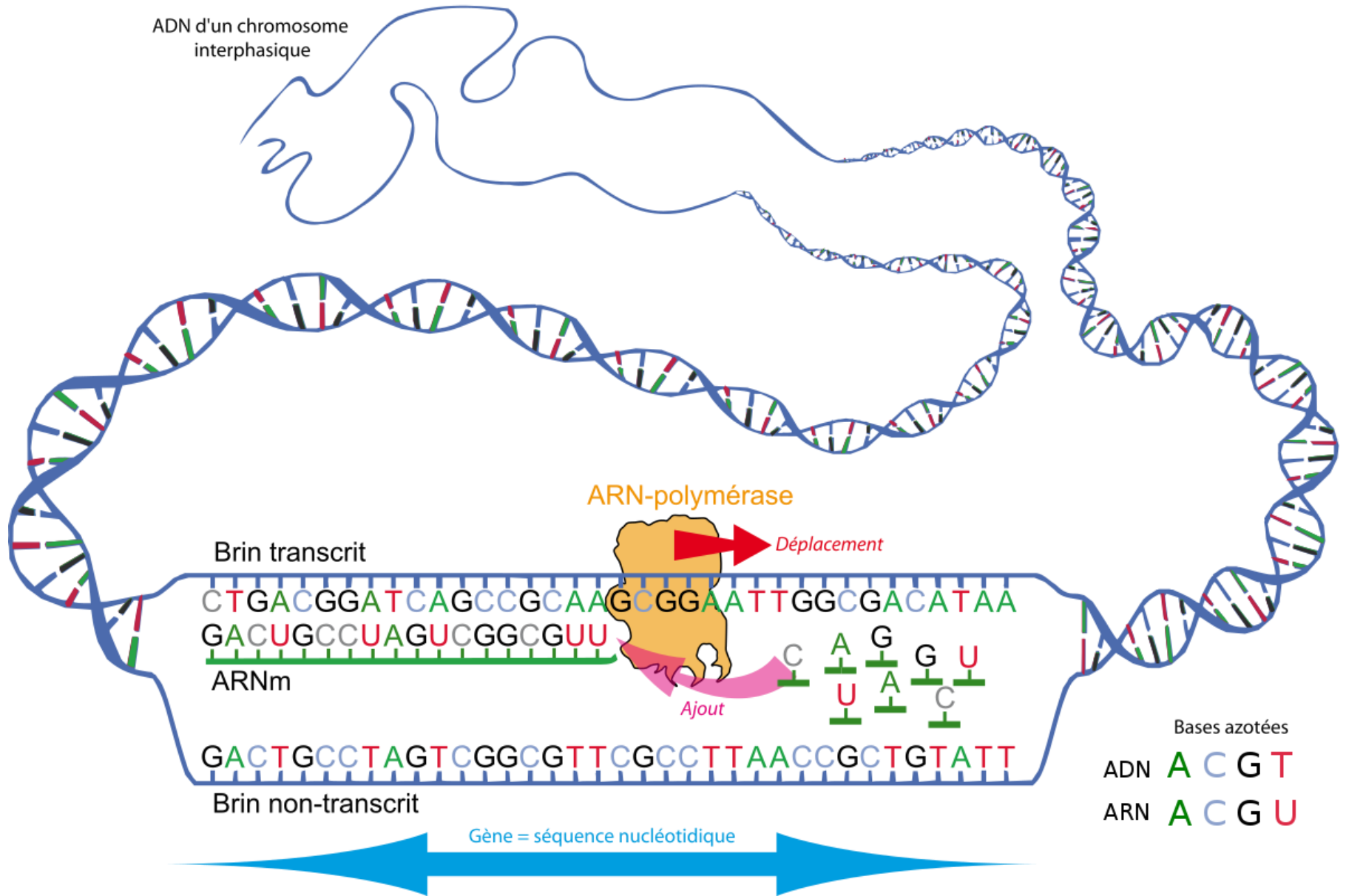

Des gènes aux protéines

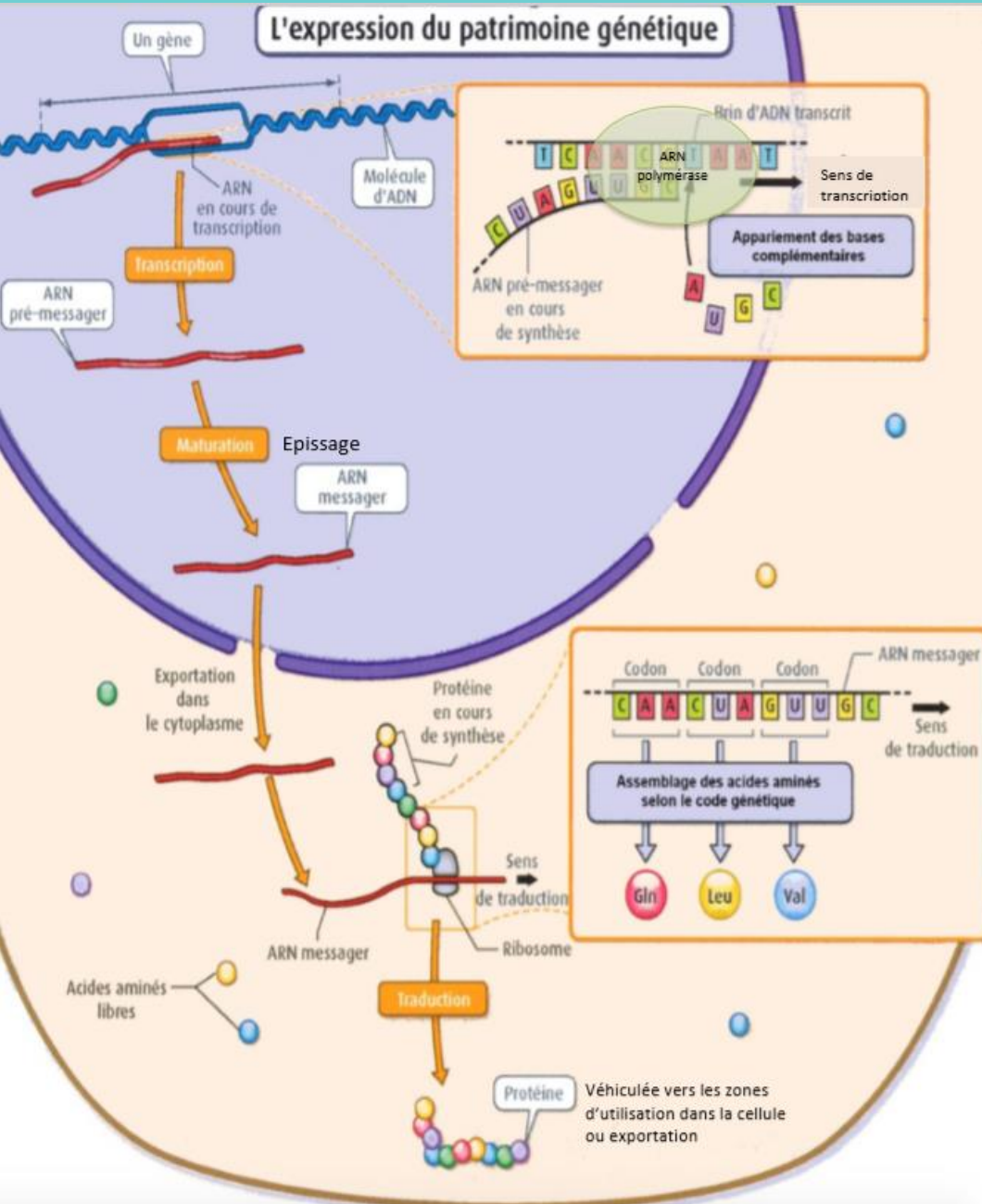

Des gènes aux protéines

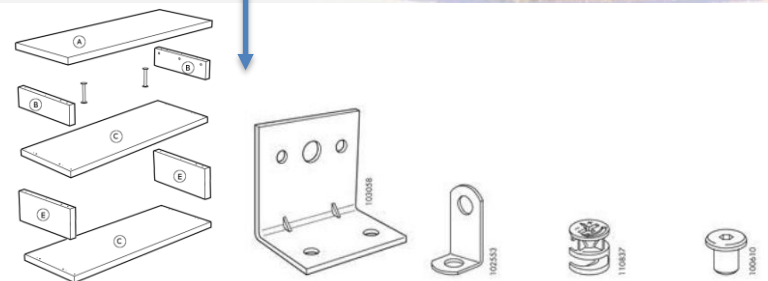
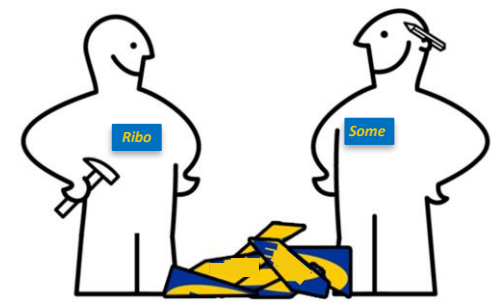
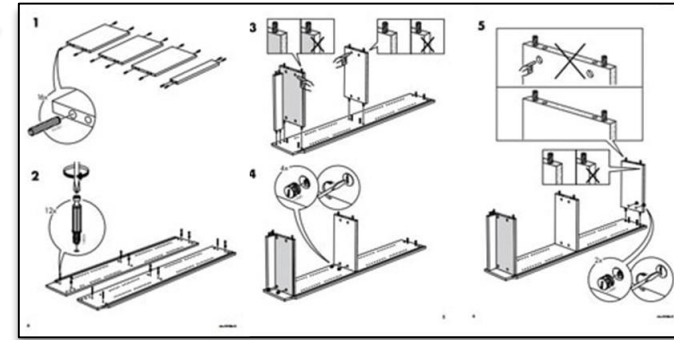
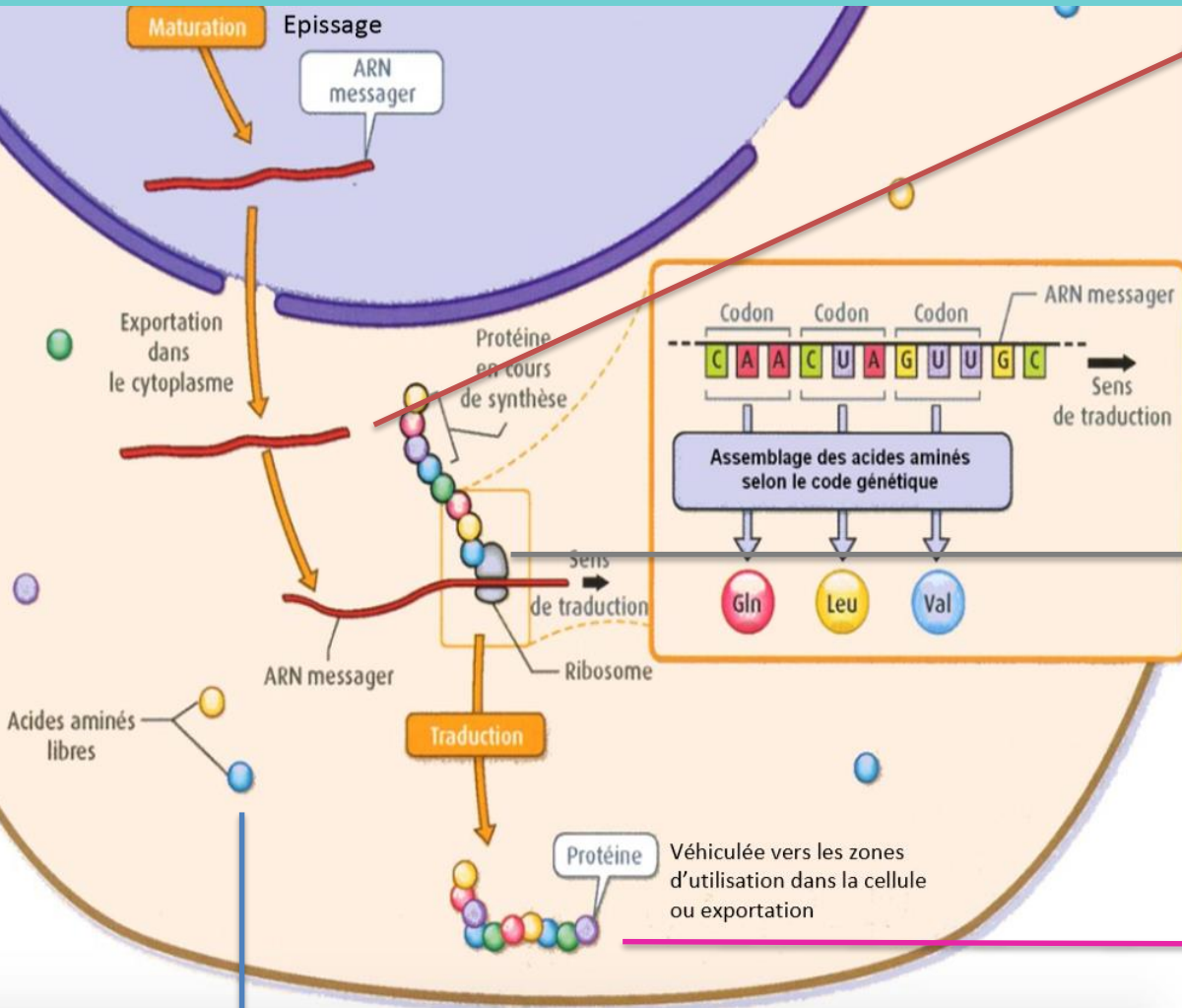

Des gènes aux protéines

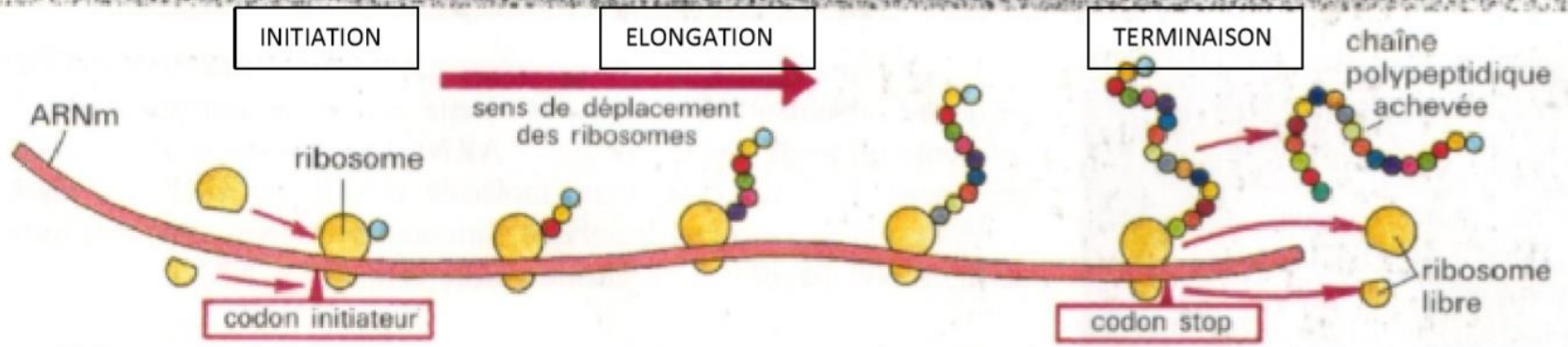
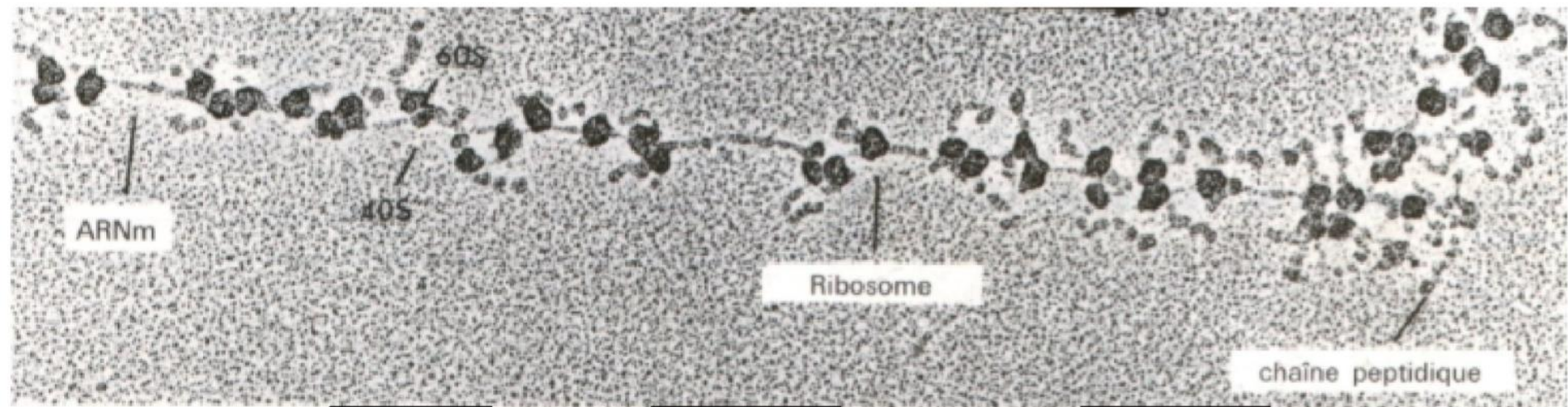

Le code génétique

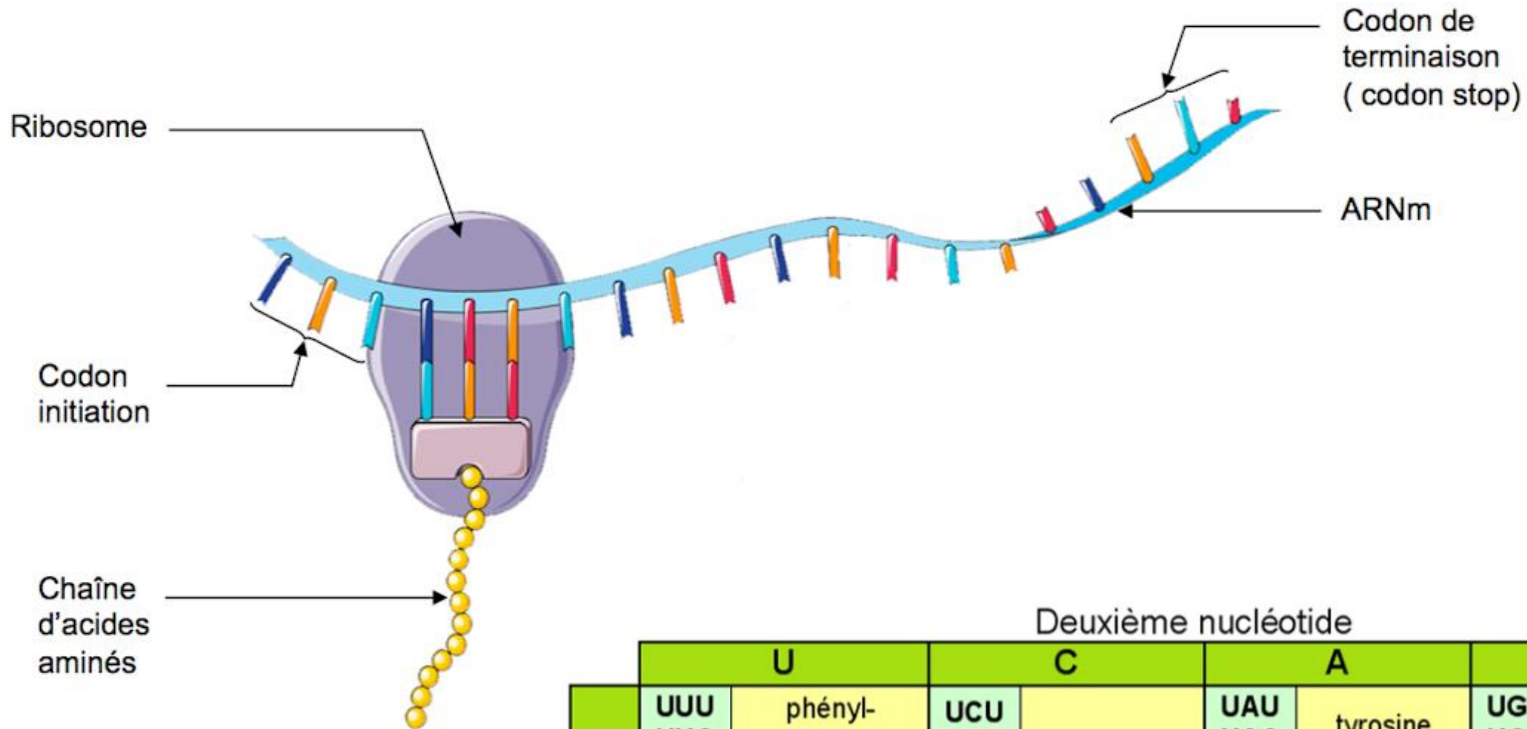

		Deuxième nucléotide								
		U		C		A		G		
U	UUU	phényl-alanine	UCU	sérine	UAU	tyrosine	UGU	cystéine	U C A G	
	UUC		UCC		UAC		UGC			
	UUA	leucine	UCA		UAA	STOP	UGA			STOP
	UUG		UCG		UAG		UGG			
C	CUU	leucine	CCU	proline	CAU	histidine	CGU	arginine	U C A G	
	CUC		CCC		CAC		CGC			
	CUA		CCA		CAA	glutamine	CGA			
	CUG		CCG		CAG		CGG			
A	AUU	isoleucine	ACU	thréonine	AAU	asparagine	AGU	sérine	U C A G	
	AUC		ACC		AAC		AGC			
	AUA		ACA		AAA	lysine	AGA			
	AUG	méthionine	ACG		AAG		AGG			arginine
G	GUU	valine	GCU	alanine	GAU	acide aspartique	GGU	glycine	U C A G	
	GUC		GCC		GAC		GGC			
	GUA		GCA		GAA	acide glutamique	GGA			
	GUG		GCG		GAG		GGG			

Des gènes aux protéines

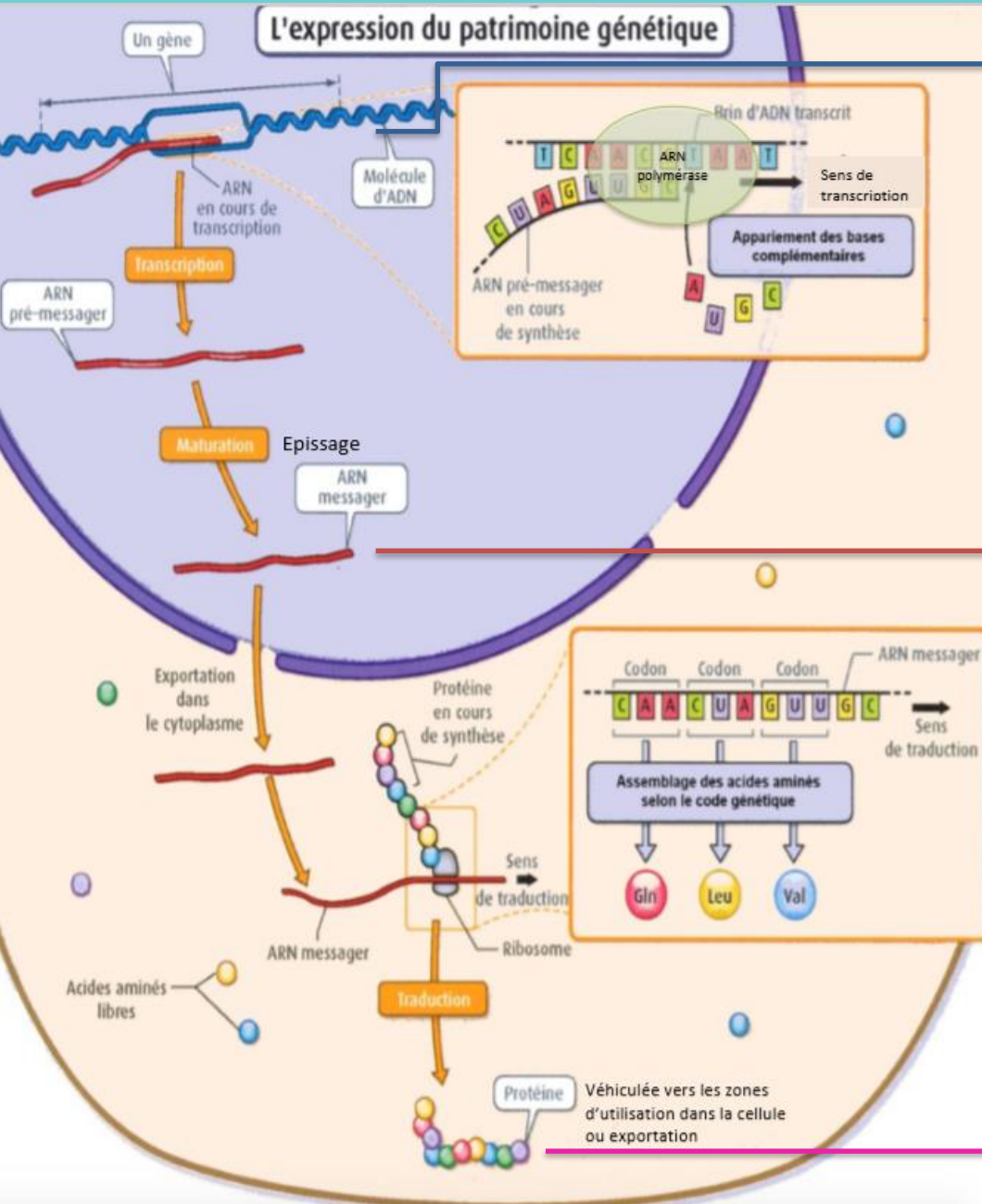

Transcription

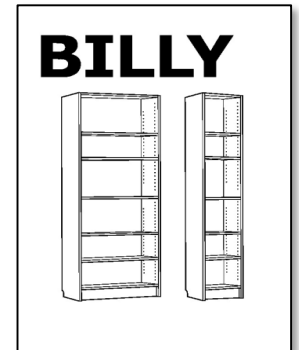

Traduction



Variation? Mutation?



Variations

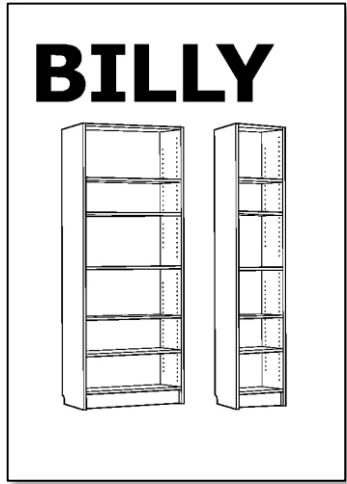

BILLY

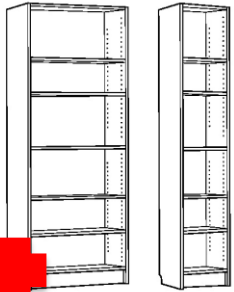

Et pourquoi j'ai que du bleu dans les yeux?

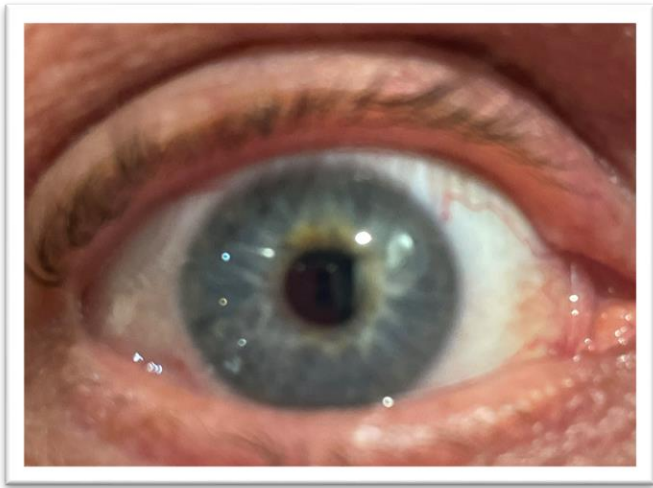

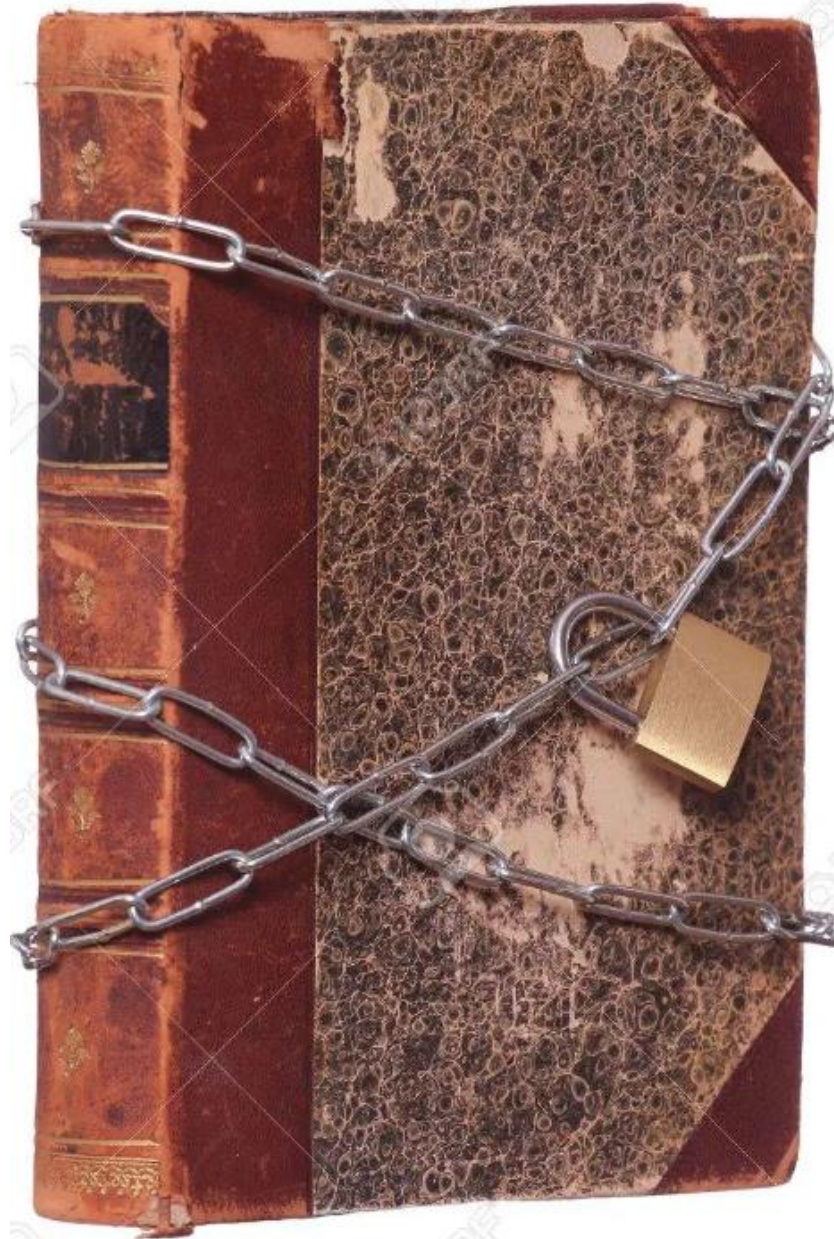

Un exemple de gène

Chromosome 9

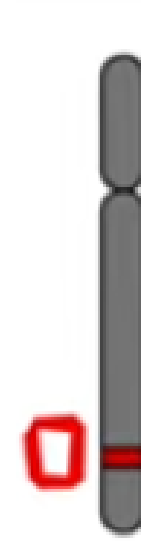
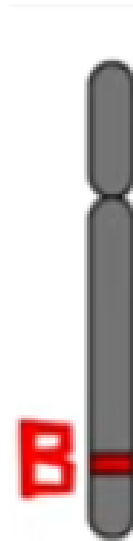
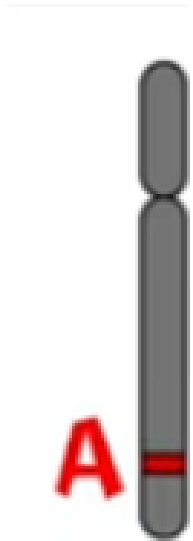

Groupes sanguins A, B et O

Génotype

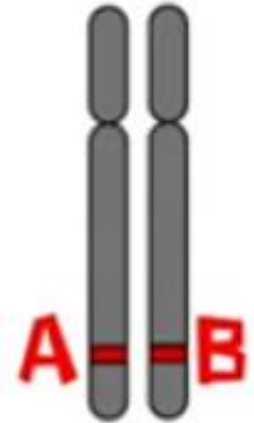
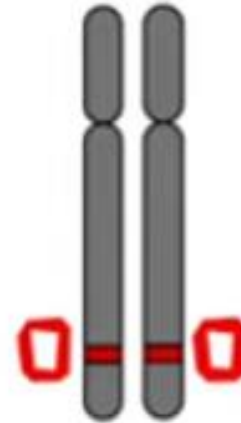
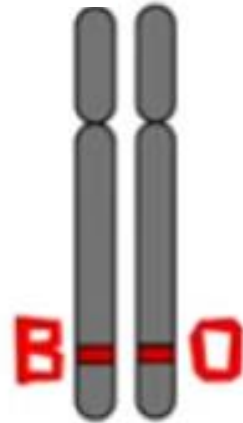
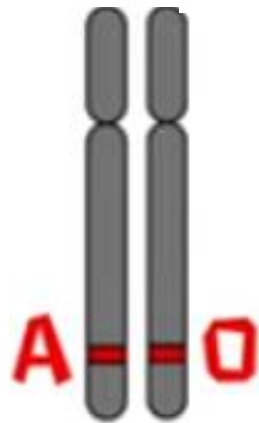
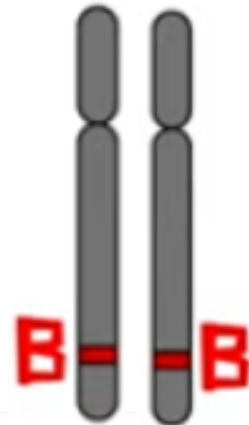
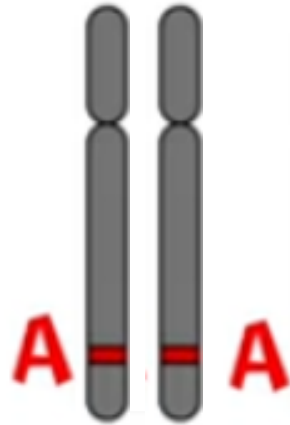

Phénotype



Groupes sanguins A, B et O

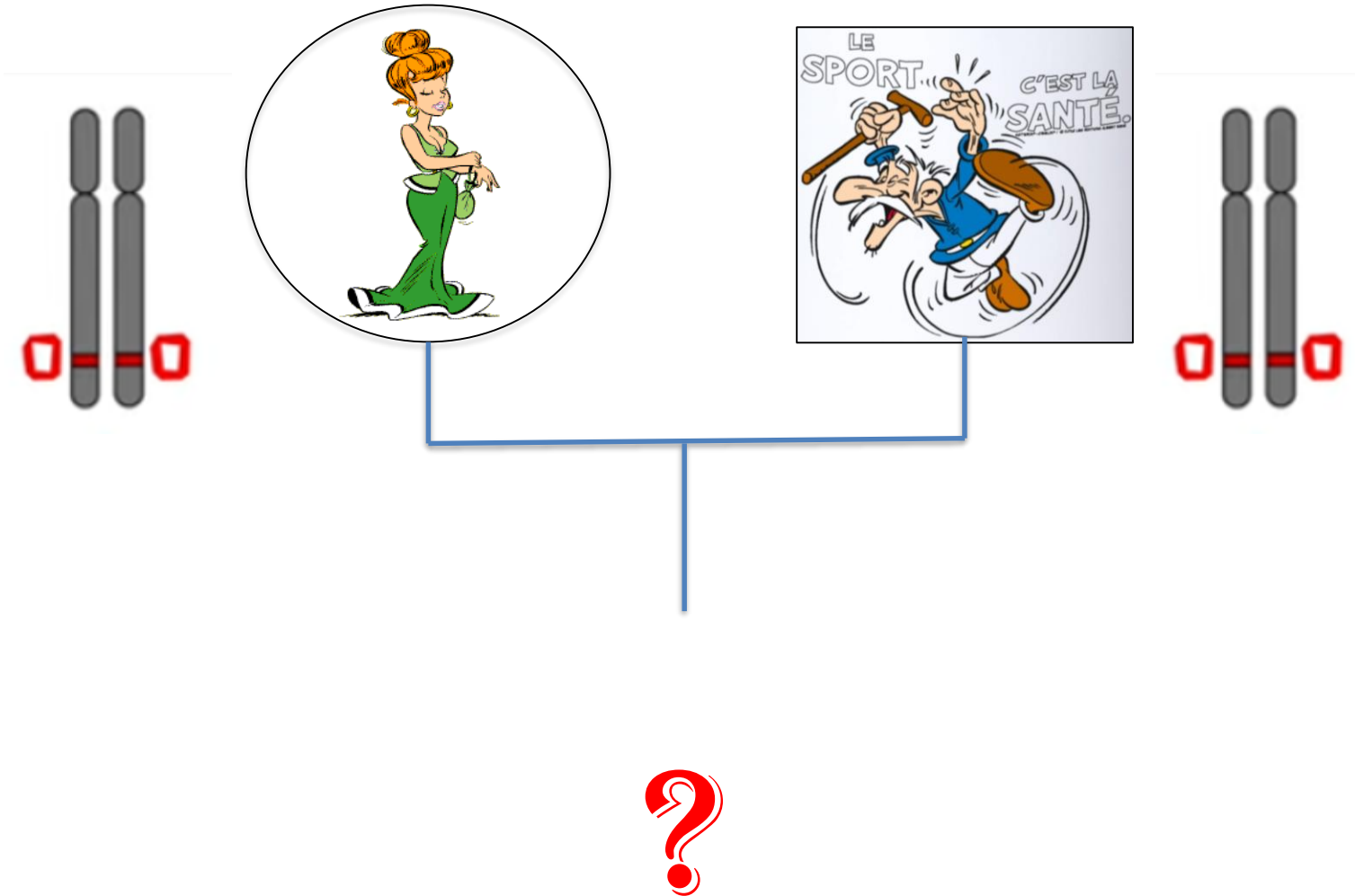

Groupes sanguins A, B et O

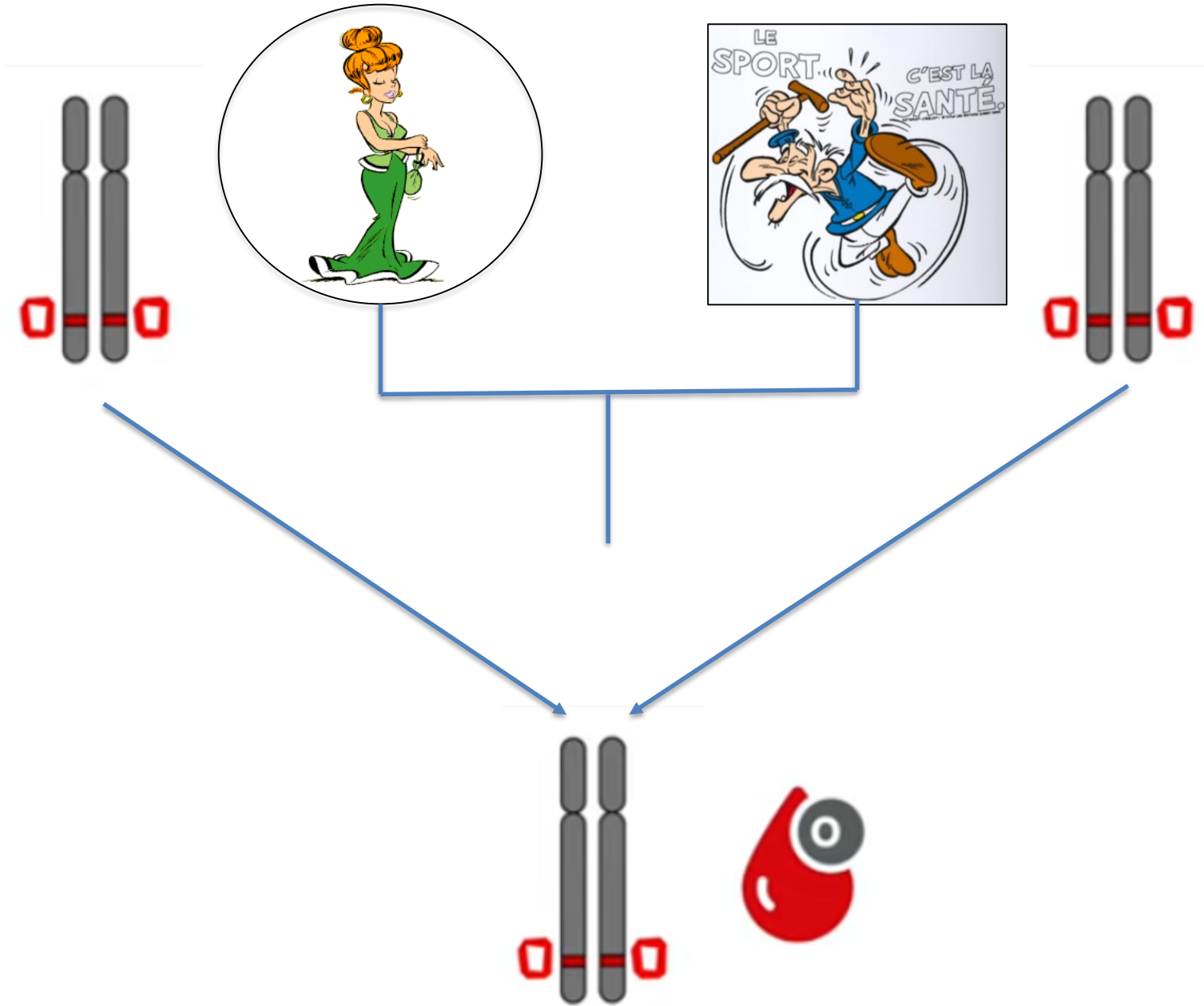

Groupes sanguins A, B et O

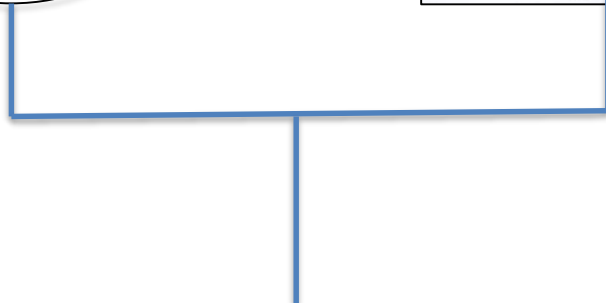
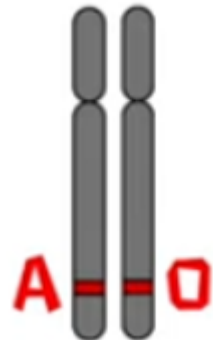
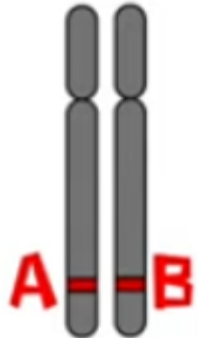

Groupes sanguins A, B et O

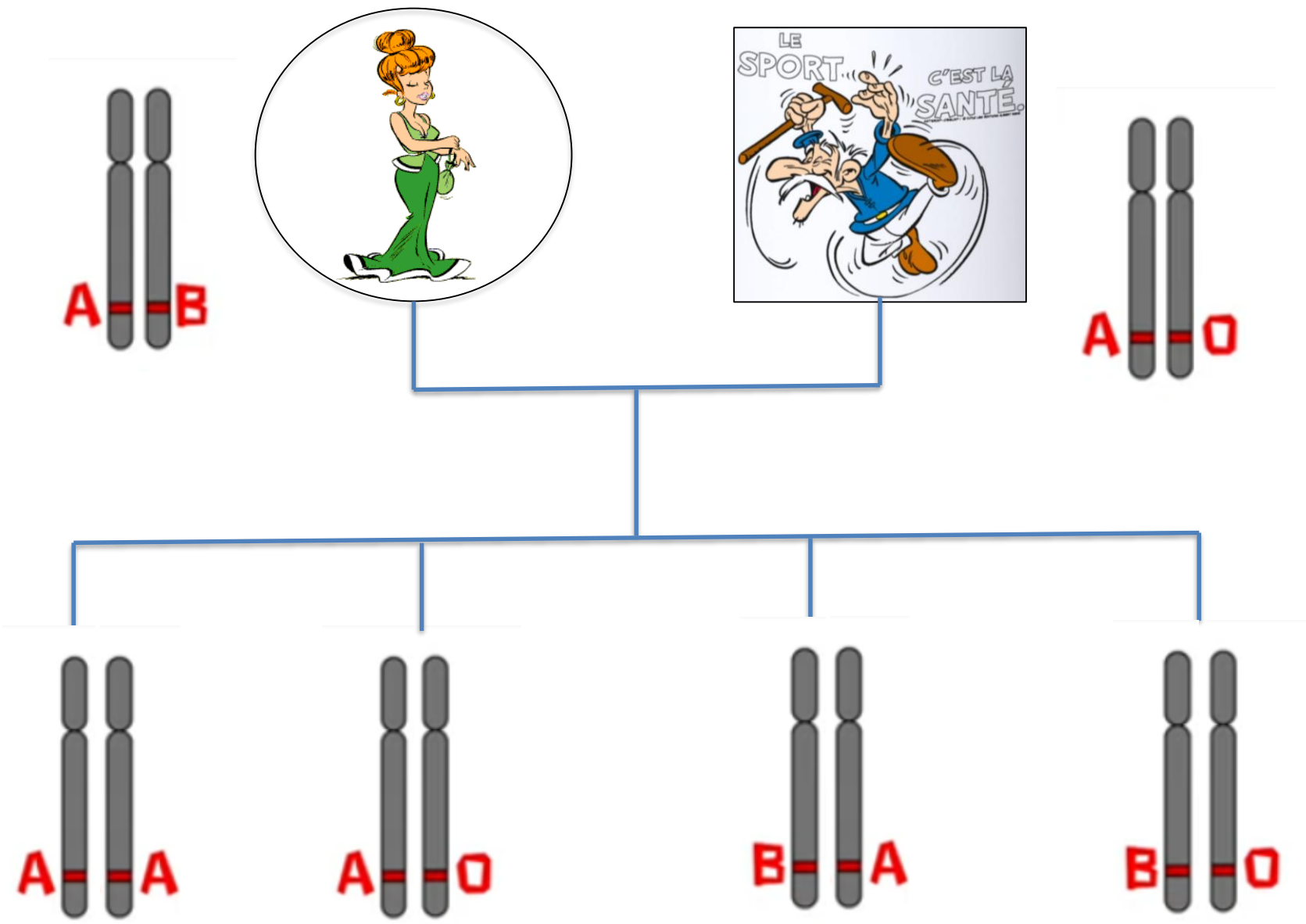

Groupes sanguins A, B et O

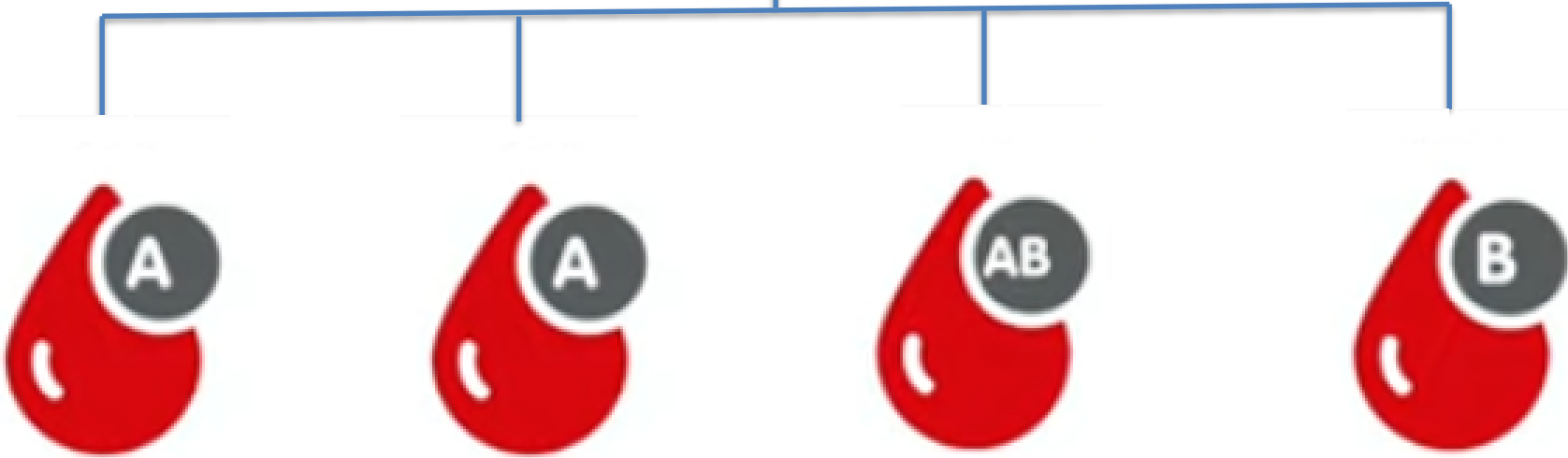
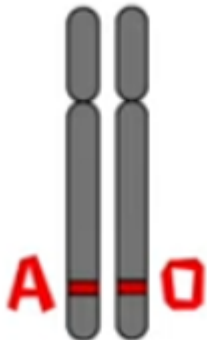
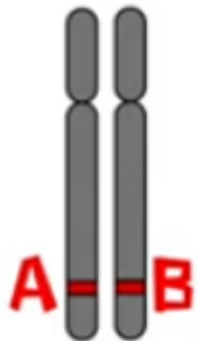

Groupes sanguins A, B et O

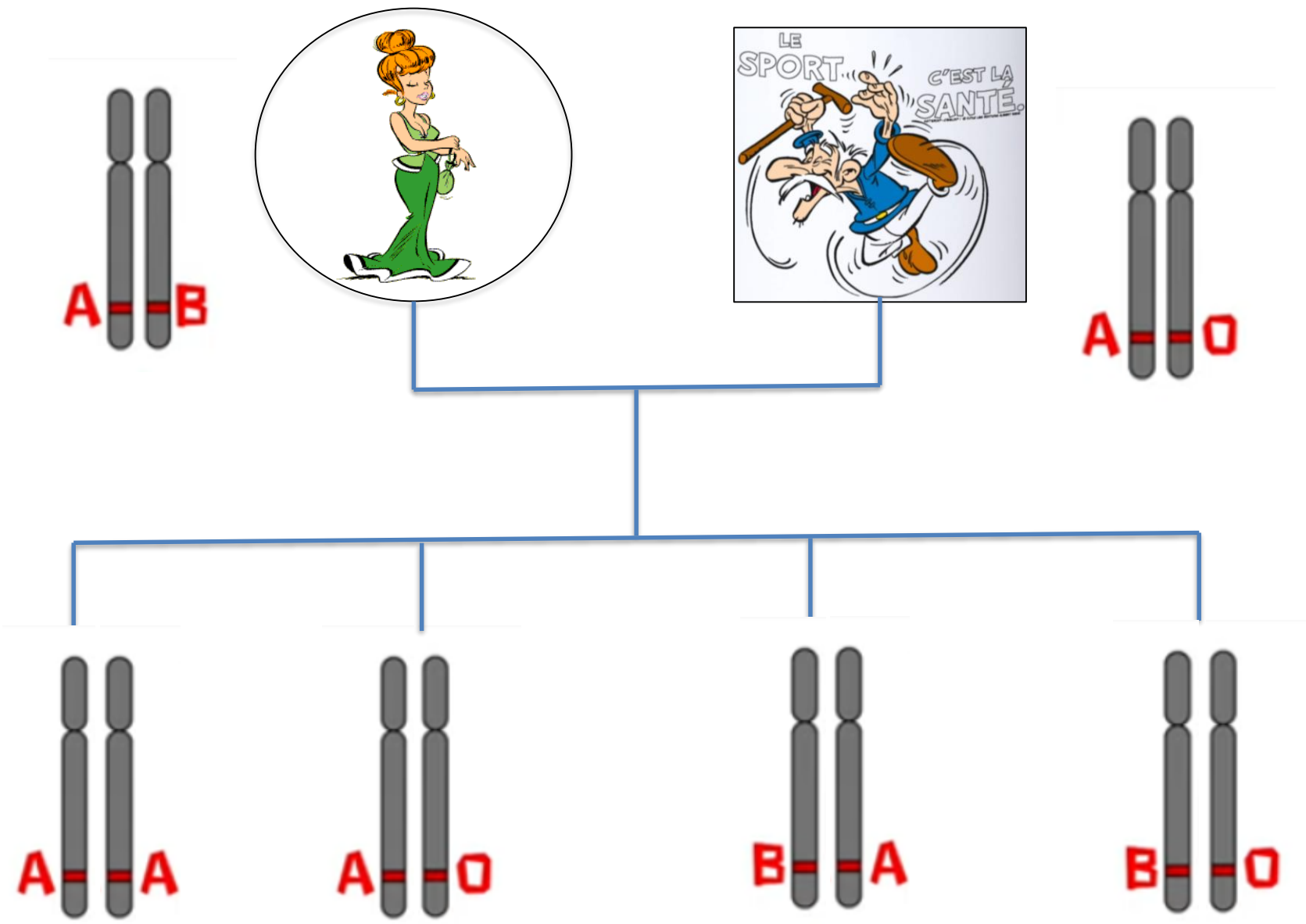

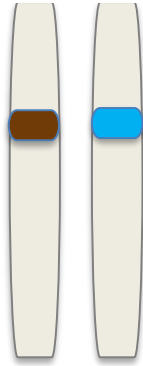

Chromosome 15
Gène Br (B, b)



Chromosome 19
Gène Ve (V, v)



- Règles de dominance des allèles
- **B est dominant** sur V et b → 
 - **V est dominant** sur b → 
 - **b est récessif** sur à V et B → 

Couleur des yeux

Chromosome 15
Gène Br (B, b)

Chromosome 19
Gène Ve (V, v)



BB	VV
Bb	VV
BB	Vb
Bb	Vb
Bb	bb
bb	VV
bb	Vb
bb	bb



Couleur des yeux



15

19

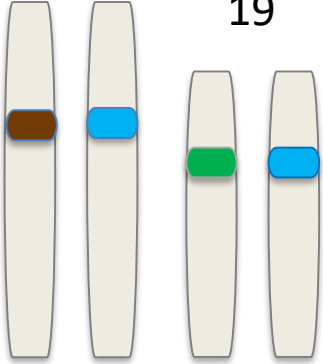

15

19

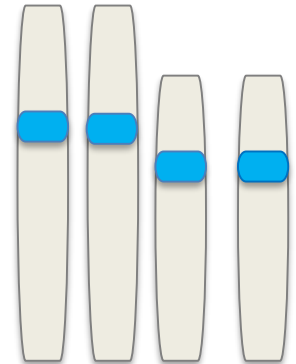
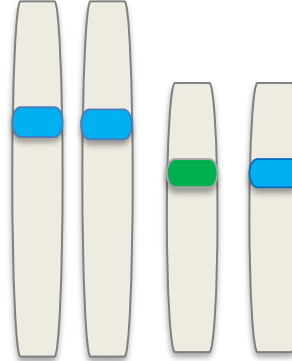
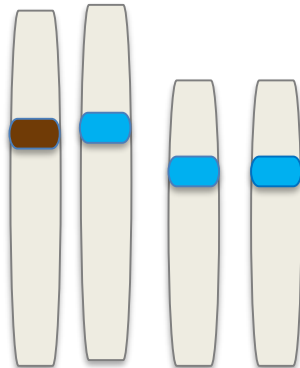
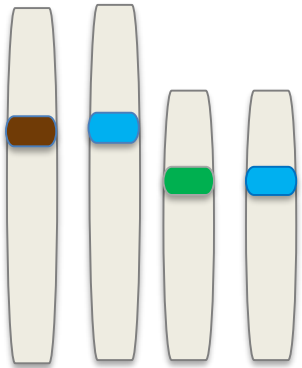
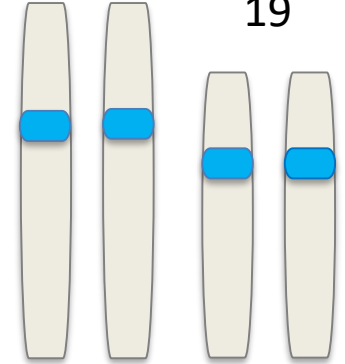

Couleur des yeux

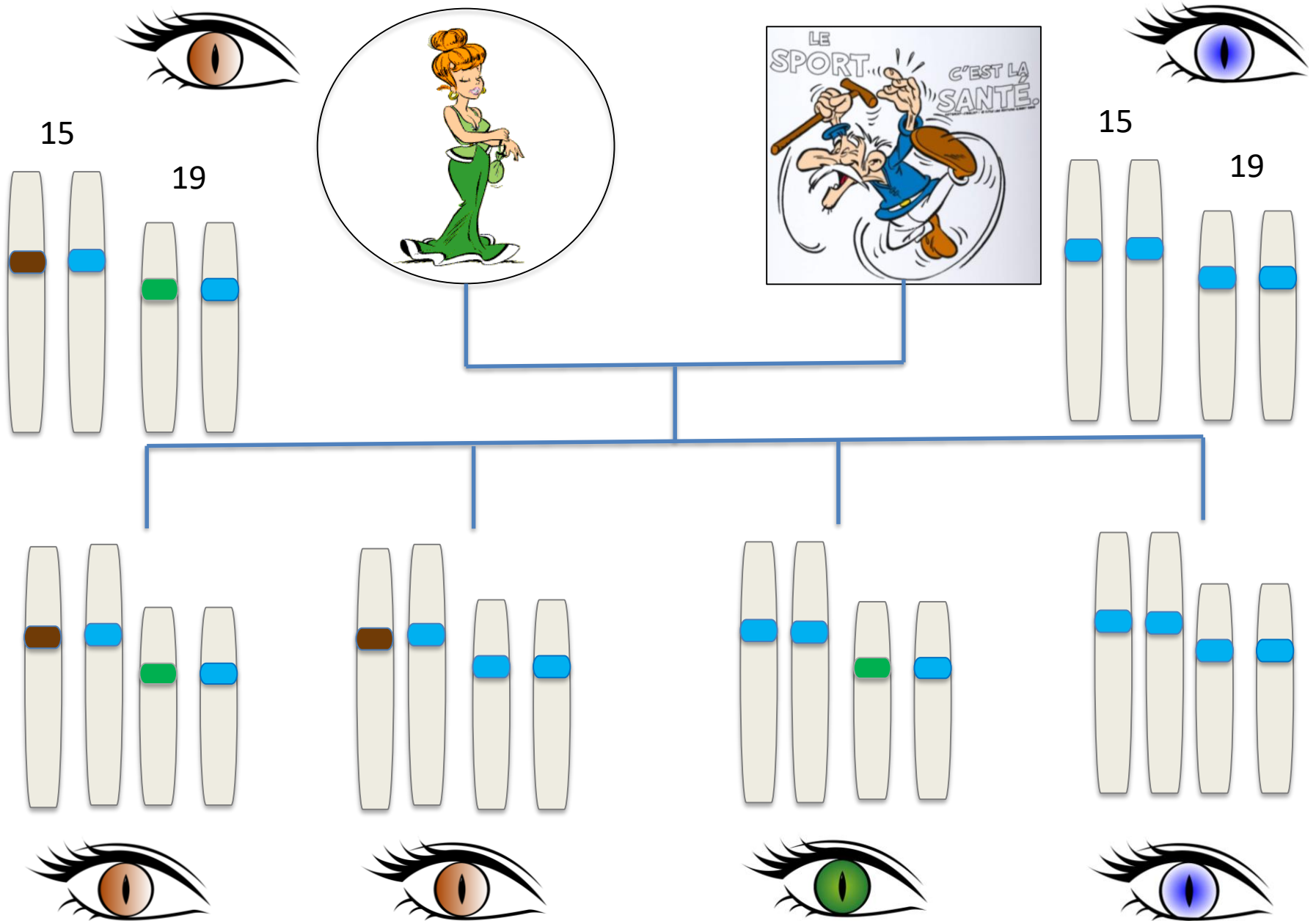

Pourquoi nous avons des variations?

La division cellulaire et la mitose – la réplication de l'ADN

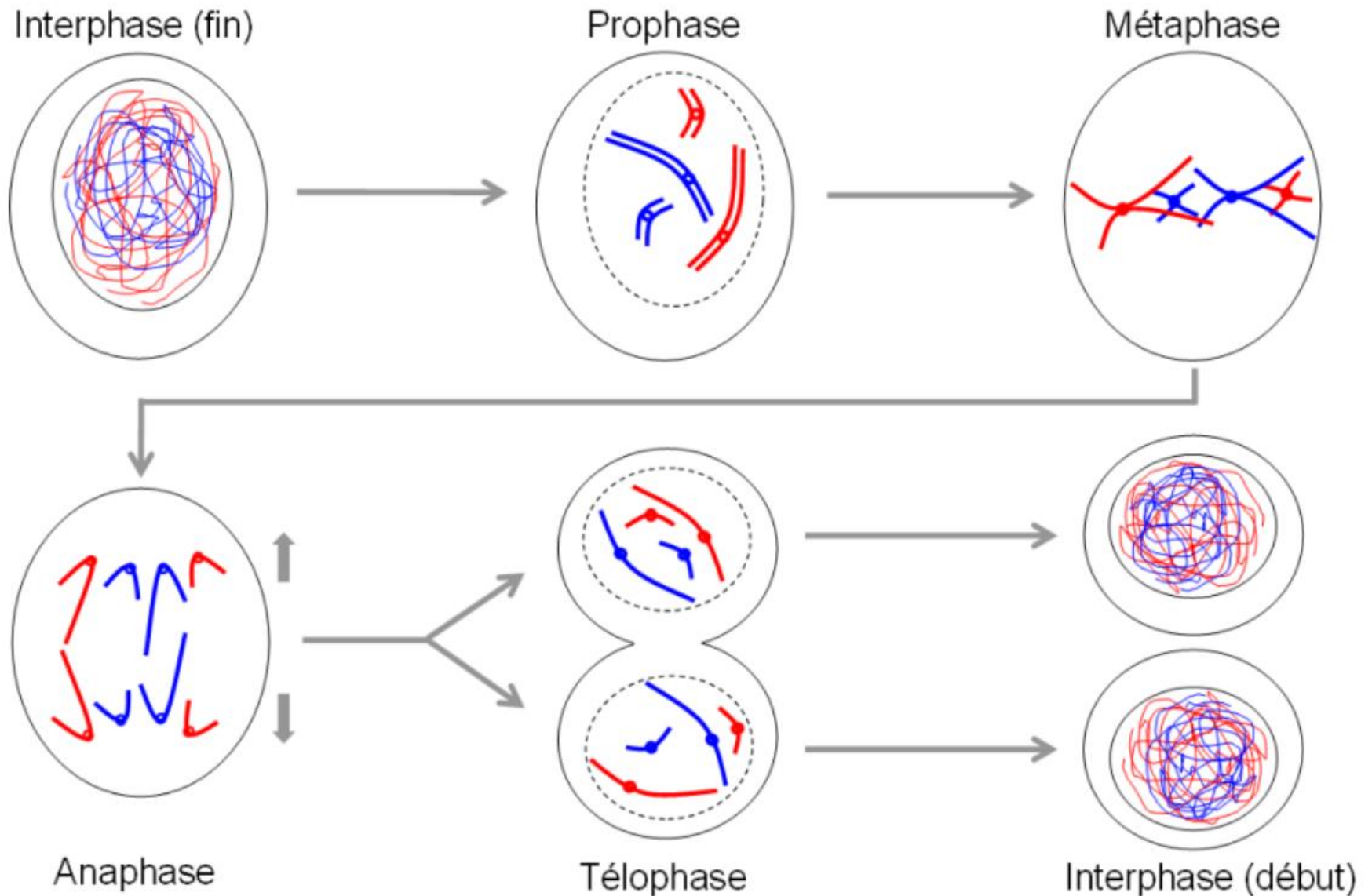

La division cellulaire et la mitose – la réplication de l'ADN

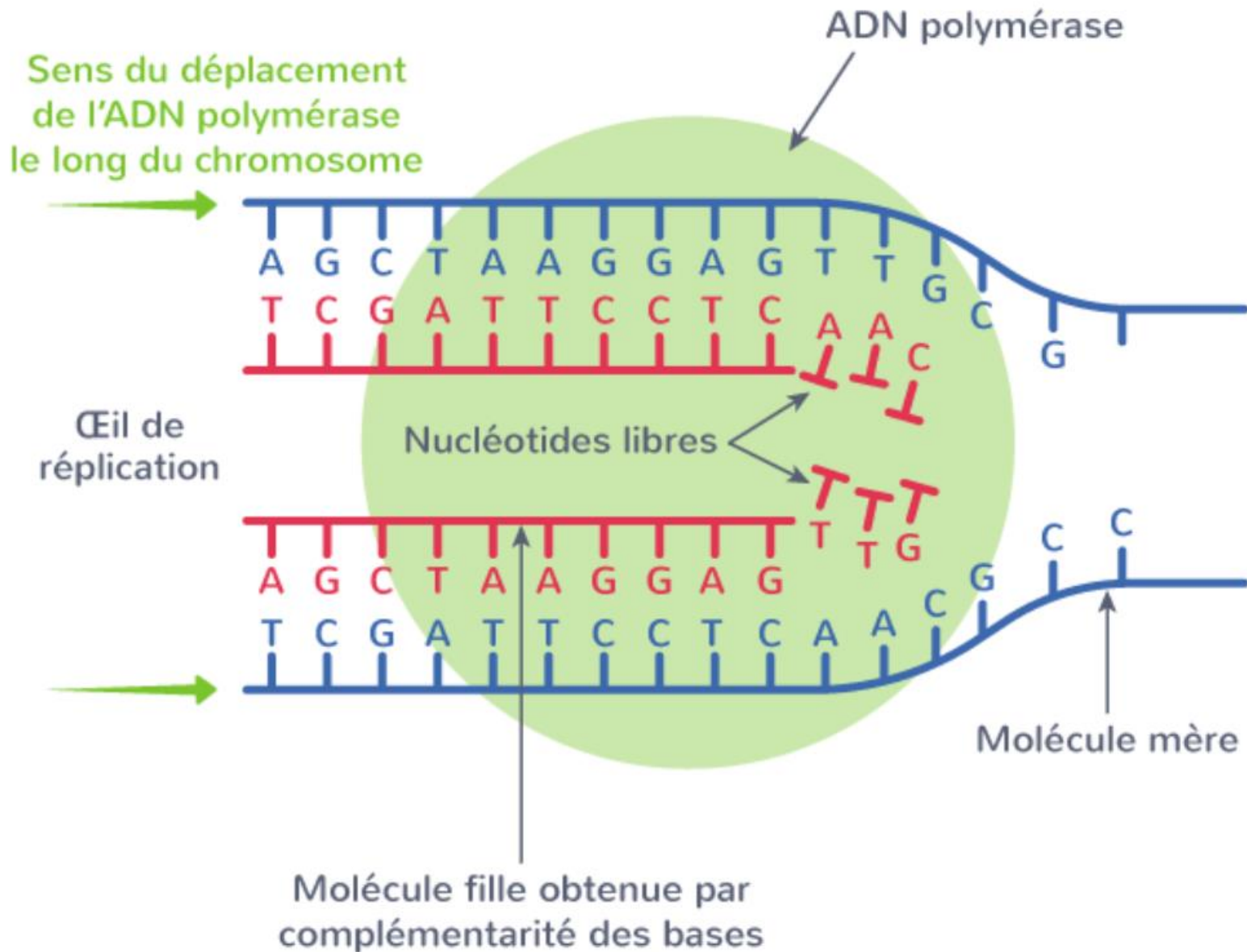

La division cellulaire et la mitose – la réplication de l'ADN

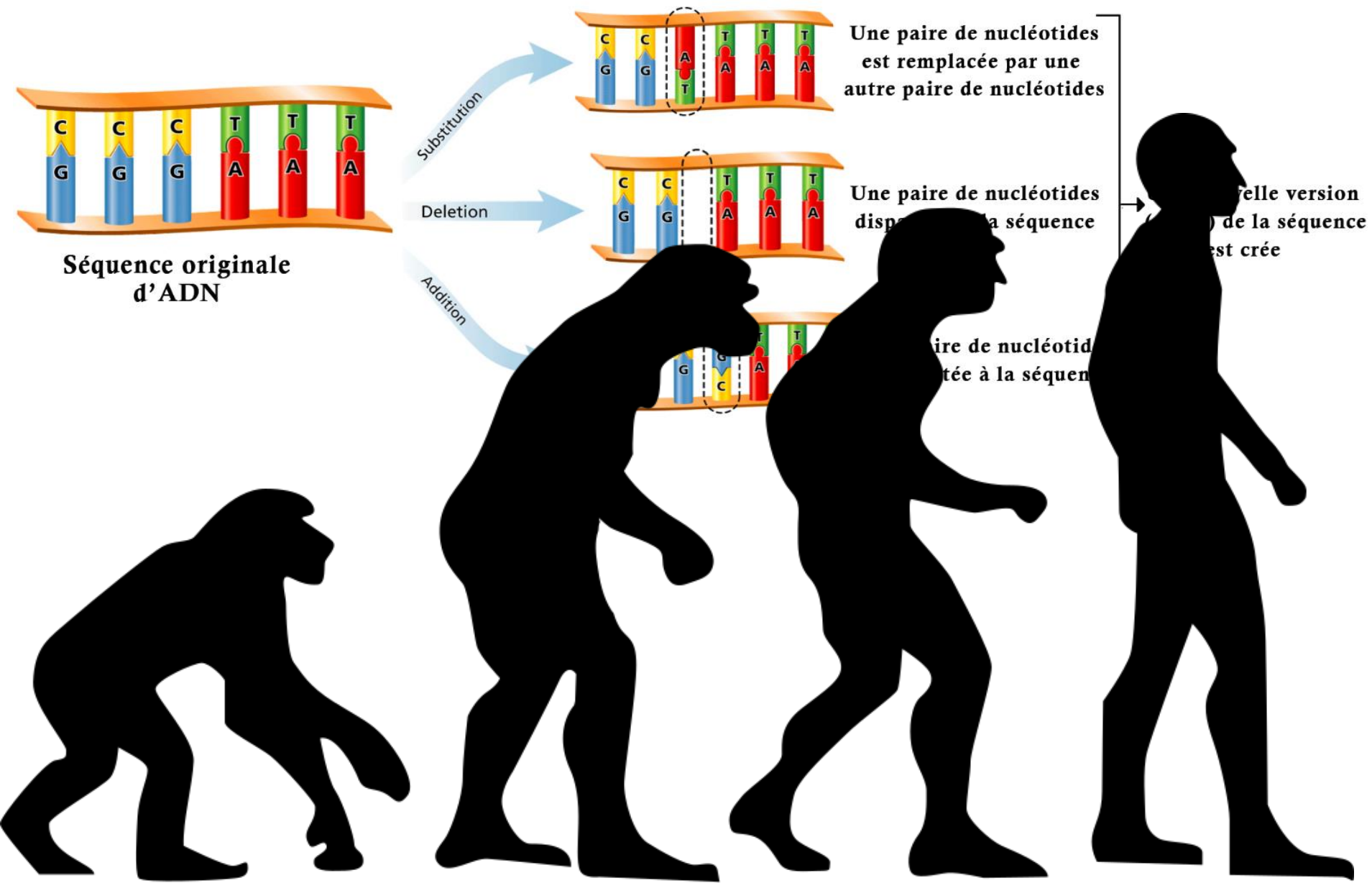

Tout savoir sur la transmission des maladies génétiques

Vendredi 13 mai

barbara.girerd@aphp.fr



filiere-oscar.fr

FILIÈRE
SANTÉ
MALADIES
RARES

Conclusion

Conclusion

Traduction

ARN polymérase

Gène

Mitose

Génotype

Epigénétique

Ribosome

Intron

Méiose

Acides nucléiques

Phénotype

Transcription

Chromosomes

Acide desoxyribonucléique

Brassage génétique

Epissage

Exon

Réplication

Ribosomes



Le Centre de Référence des Maladies du métabolisme du Calcium et du Phosphate, Hôpital Bicêtre

Agnes Linglart
Anya Rothenbuhler
Claire Bouvatier
Anne Sophie Lambert
Julia André, MA Trouvin

Le Centre de Référence des Maladies Osseuses Constitutionnelles, Hôpital Necker

Valérie Cormier Daire
Geneviève Baujat
Caroline Michot
Pauline Marzin



*Merci à Hergé, Uderzo, Peyo et J-R Girerd pour les illustrations.
Merci à Billy, grâce à qui j'ai développé une expertise inédite.*

** Toute ressemblance avec une grande marque d'ameublement existante serait purement fortuite !*

On se revoit bientôt pour la suite des aventures, dans.....

Tout savoir sur la transmission des maladies génétiques

Vendredi 13 mai

barbara.girerd@aphp.fr



filiere-oscar.fr

FILIÈRE
SANTÉ
MALADIES
RARES